

... technologies for a reliable hold

Fasteners for thin sheet metal

Anchor®
Clifa®

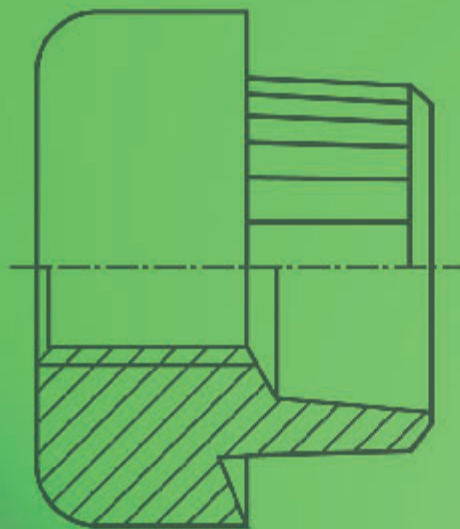

Technical publication

No.40

**Kerb
Konus** 



Fastening technology from KerbKonus are in successful applications in a wide variety of different industrial sectors around the world.

State-of-the-art production facilities provide our customers with the assurance of quality and reliable delivery, and sophisticated fastening solutions for every conceivable field of application are implemented by our own Research and Development Department.

Close cooperation and exchange of experience and expertise on an international level ensure that our company stays at the cutting edge of technological development.

With independent branches and agencies operating in a number of countries around the world we are a truly reliable partner when it comes to secure fastening technology.

... our products and services

Depending on the required anchoring method in the material, KerbKonus offers a variety of threaded insert options:

- self-tapping threaded inserts for metal, wood and plastics,
- Threaded inserts for cold embedding
- Threaded inserts for hot or sound embedding
- Threaded inserts for screwing into an internal thread
- Threaded inserts for riveting

Alongside its long-standing, proven spectrum of threaded inserts for a wide variety of applications, KerbKonus also offers a range of fastening technology-related products and services:

- Punched rivet system for thin mouldings
- Screw locking
- Thread sealing systems
- Insulating plastic coating

If you have a specific problem related to the field of fastening technology - with its rich fund of expertise and comprehensive product range, KerbKonus has the solution for you.

Technical details on KerbKonus products are also provided on our homepage: www.kerbkonus.de

Kerb-Konus-Vertriebs-GmbH

Wernher-von-Braun-Straße 7
Industriegebiet Nord

D-92224 Amberg

Phone +49 9621 679-0
Fax +49 9621 679444
e-mail KKV-Amberg@kerbkonus.de

Internet www.kerbkonus.de



Dimensions Product features Receiving hole Torque strength Specifications Other details

Threaded inserts from KerbKonus ...

Tested quality; Test methods
Anchor - Fields of application and product features

Page 2 to 3
Page 4 to 5



Anchor® rivet bushing

M2 to M16	Standard version	Pre-punched drilled	high	Works Standard 701 0 to 718 0	Page 7
-----------	------------------	---------------------	------	-------------------------------	--------

Anchor® installation

Tools

Page 6



Anchor®-Mini

M2 to M8	Weight and space-saving	Pre-punched drilled	medium	Works Standard 721 to 738	Page 8
----------	-------------------------	---------------------	--------	---------------------------	--------



Anchor® tank type

M3 to M12	Threaded blind hole	Pre-punched drilled	high	Works Standard 741 to 758	Page 9
-----------	---------------------	---------------------	------	---------------------------	--------

Clifa® press-in nut and stud

Fields of application, product features and installation instructions

Page 10

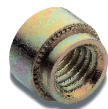

Clifa®-M

M2 to M10	for metal	Pre-punched drilled	high	Works Standard 500 0 to 503 0	Page 11
-----------	-----------	---------------------	------	-------------------------------	---------



Clifa®-AM

M3 to M5	Spacer bushing for metals	Pre-punched drilled	high	Works Standard 503 8 to 525 8	Page 12
----------	---------------------------	---------------------	------	-------------------------------	---------



Clifa®-AL

M2 to M5	Spacer bushing for plastics	Pre-punched drilled	medium	Works Standard 503 6 to 525 6	Page 13
----------	-----------------------------	---------------------	--------	-------------------------------	---------



Clifa®-SP/-SR

M2,5 to M8	for pressing-in flush to the surface. SP coarse tothing SR fine tothing	Pre-punched drilled	medium	Works Standard 506 0 to 534 0	Page 14
				Works Standard 506 1 to 534 1	



Clifa®-SL

M3 to M5	for plastics	Pre-punched drilled	medium	Works Standard 506 7 to 518 7	Page 15
----------	--------------	---------------------	--------	-------------------------------	---------



Clifa®-SA

M4 to M10	for high loads drilled	Pre-punched	high	Works Standard 515 4 to 534 4	Page 16
-----------	------------------------	-------------	------	-------------------------------	---------

Clifa® enquiry data sheet

on custom-produced Clifa press-in studs

Page 17

Economical processing

Economic benefits through the use of threaded inserts

Page 19

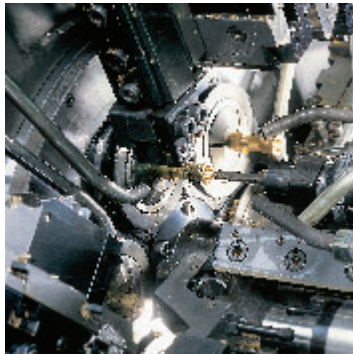
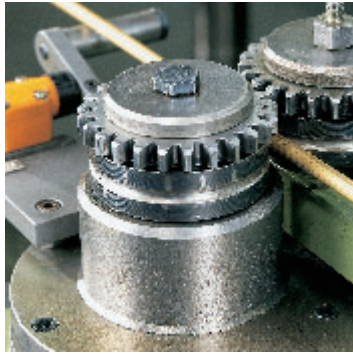

At our parent plant in Amberg, we produce threaded inserts using efficient production methods. A team of qualified and highly motivated staff guarantees a consistent, high standard of production.

The number of products manufactured over the company's history reaches into the billions. State-of-the-art automation lines manufacture around the clock in a precise and high standard of quality. The efficient and low-cost production of large-scale product series is one of the strengths on which we have based our success.

But our high-volume production output in no way compromises flexibility. We are able to quickly and efficiently produce even small batches of non-standard items.

Our state of the art stock control system permits the reliable, prompt delivery of standard products, keeping your production running to schedule at all times and helping to minimize your warehousing costs.

We are particularly proud of a cost-to-performance ratio which ensures satisfied customers the world over. This has made KerbKonus a reputable and respected partner to industry in the global marketplace.

Quality is a top priority issue at KerbKonus. Quality consciousness is a continuous thread running through every aspect of the company's work and all its products and services. Quality is lived and breathed at KerbKonus.

All the most important certifications and approvals are always kept consistently up to date, and our company is audited regularly for compliance with the most important international standards.

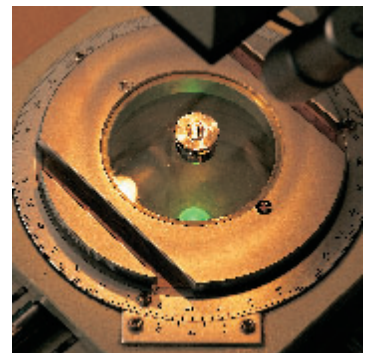
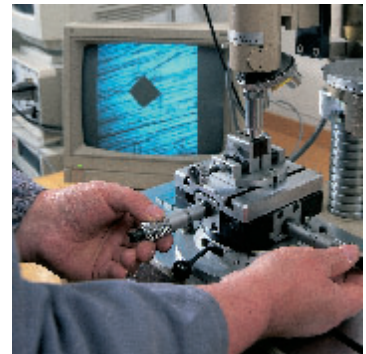

What really counts: tested quality.



Quality System
DQS Certificate in accordance with
DIN EN ISO 9001:2000 Reg. no. 001743 QM
ISO/TS 16949:2002 Reg. no. 64443 TS2/78

Applications on the test stand ...

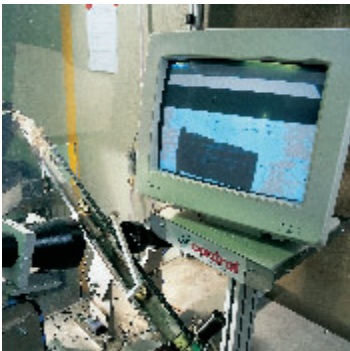

Threaded inserts from KerbKonus are manufactured in large piece numbers. Human lives and safety can often depend upon these tiny components, for instance in the case of airbag receiving fasteners.

Because we bear this heavy responsibility, our products are tested and monitored in line with the most stringent directives. In the case of particularly critical applications, each and every part is exhaustively tested on state-of-the-art test equipment before it is delivered to you.

Test methods

The loading capacity of a thread depends primarily on the surface shell of the component which is exposed to shearing stress.

By selecting just the right threaded insert for each application, maximum reliability can be achieved.

Using tried and tested, practically oriented test methods (see the table below), we provide the designer with a set of reliable specifications to ensure safe, reliable compliance with any application requirement, however unusual. In most cases, this can even be achieved using standard threaded inserts.

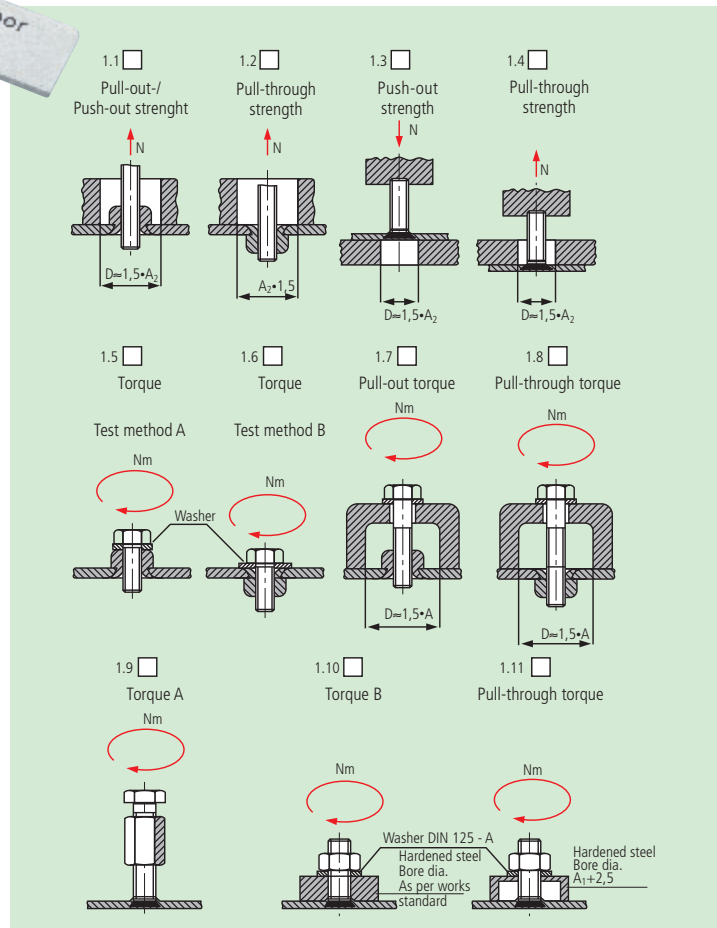
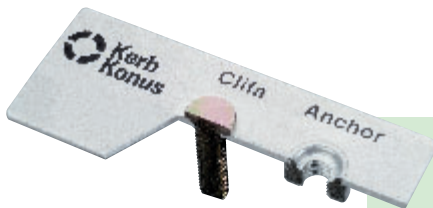

Anchor[®] - serrated rivet bushing ...

The Anchor rivet bushing is a threaded insert made of steel or rustproof material, brass or light alloy with a counter-bored and serrated shank.

Anchor is riveted into thin-walled moulded parts with pre-punched receiving holes. During this process, the riveted serrations of the shank cut into the side wall, creating an absolutely secure fastening.

The special shape of the shank and the countersinking at the bottom protect the thread from damage during installation. In almost all application cases, overload testing indicated that Anchor remains firmly seated even if the thread is completely overtorqued.



Fields of application

Anchor rivet bushings enjoy universal application, offering a wide variety of design possibilities: for hardwearing screw connections in the automotive industry, for reliable fixture of highly sensitive electronic parts etc.

Product features

- Anchor is torque-resistant and capable of loads applied from both sides.
- Anchor can be used in surface-treated, ready-plated parts, so eliminating the need for time-consuming cleaning of internal threads and reworking damage at the surface.
- When turning in the screw, it is impossible for the Anchor to be forced out of the hole. This saves incalculable time losses.
- The Anchor thread is clean, true to gauge and is wear-resistant. It has a precisely fitted centered seat without the need to use templates or other positioning devices.

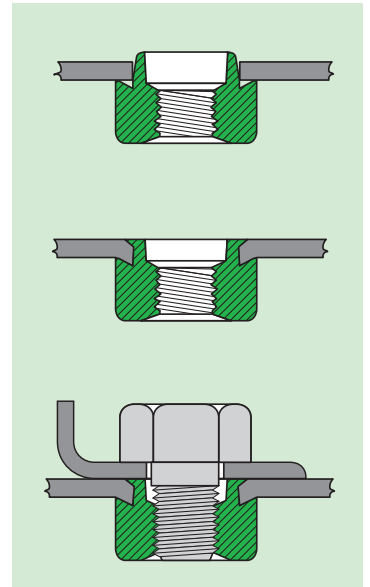

Specifications

Works standard sheets 701 to 758, page 7 - 9

On request:
Special Anchor-S with screw lock TufLok in the internal thread. The captive plastic support serves as a safeguard against the screw working loose of its own accord.

Also available:
Special Anchor-D with sealing agent precote 5 on the contact surface.

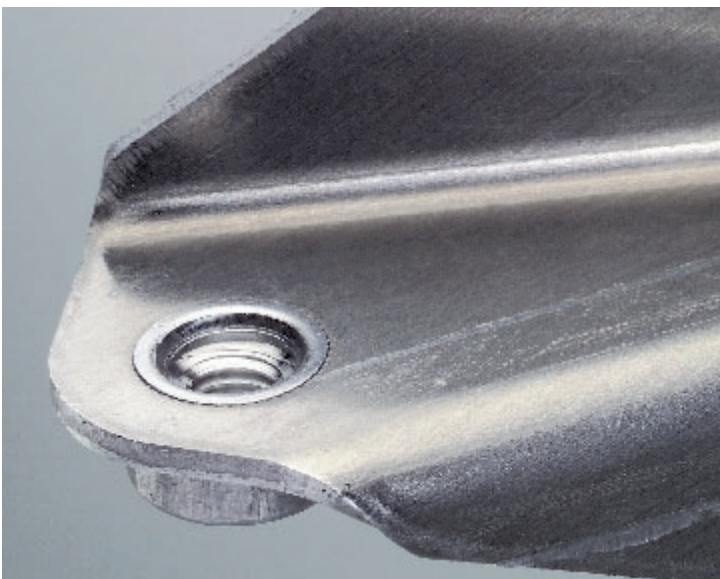

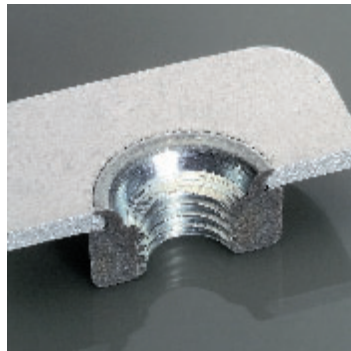
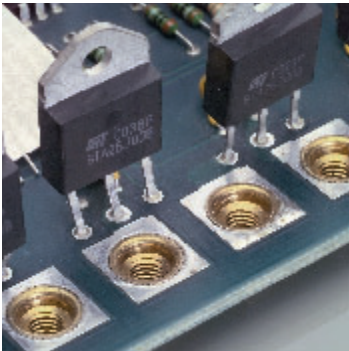

Special request

- Space and weight-saving design

- Thread seal

- Distanced fixture

- Support or bearing function

- Flush finish to the surface of the metal

- Extremely high loads (torque / push-out forces) or seal between the Anchor and the sheet metal

- If lower seating strength is sufficient, e.g. in plastic or soft metal panels

We recommend

- Mini-Anchor with small outer dimensions (Works Standard 721 to 738)

- Tank-type Anchor with blind thread (Works Standard 741 to 758)

- Anchor in special lengths

- Anchor without internal thread (special version)

- Processing using Anchor with tumble or radial rivetting machine, or use Anchor for the next smallest sheet metal thickness

- Select a smaller receiving hole and fix Anchor with a hollow punch before rivetting. (Or in a single work process using a combined setting and rivetting tool).

- Simply press in Anchor without rivetting. In the case of circuit boards, for example, the shank can also be soldered.

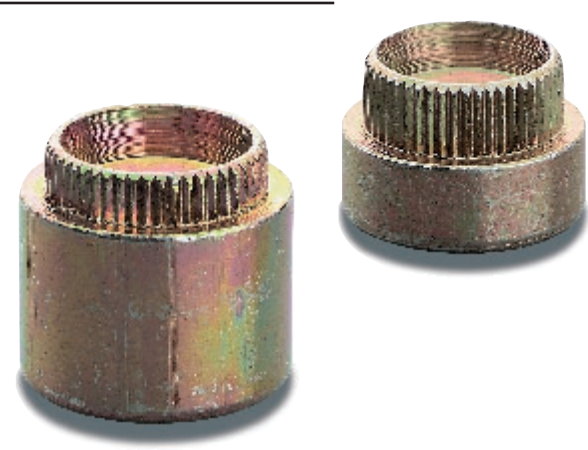
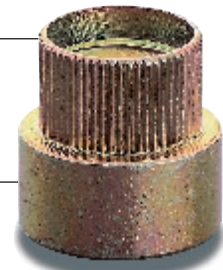

Anchor[®] installation ...

Installation

Punch or drill a hole, insert Anchor and rivet the shank with a simple rivetting tool (Fig. 1 + 2):

- manually
- using a pneumatic manual rivetting hammer
- using a simple press
- by inserting Anchor and rivetting using a tumble or radial rivetting process
- automatic feed in follow-on tools
- with special high-performance installation devices for large-scale series. Output up to 50 parts per minute
- for high rivetting forces, use a double-acting rivetting tool because of the extreme torque load or thin wall of the moulded part (Fig. 3)

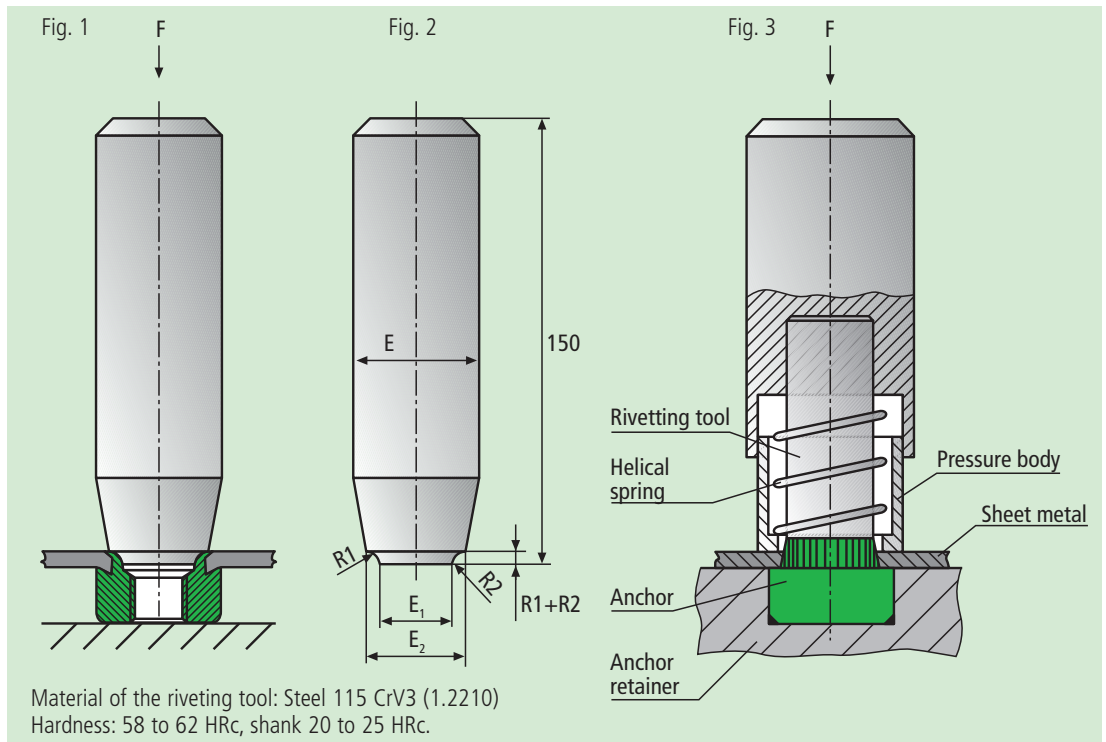

Rivetting pressure P with mechanical rivetting (Anchor made of steel)

M 2 / M 3	appr.	15 to 27 kN
M 4		20 to 30 kN
M 5		22 to 42 kN
M 6		30 to 54 kN
M 8		45 to 81 kN
M 10		65 to 97 kN
M 12 - M16		80 to 160 kN

Dimensions of the rivetting tools (Fig. 2):

	Article no. 401 ... for Anchor and Tank Type					Article no 421 ... for Mini-Anchor				
	E1	R1	R2	E2	E	E1	R1	R2	E2	E
M 2	4,3	0,6	0,5	7,1	12	2,4	0,6	0,5	4,8	12
M 2,5/ M 3	4,3	0,6	0,5	7,1	12	3,2	0,6	0,5	5,5	12
M 3,5/ M 4	5,3	0,7	0,5	8,7	12	4,3	0,6	0,5	7,1	12
M 5	6,7	0,9	0,5	10,3	16	5,3	0,6	0,5	8,7	12
M 6	8,0	1,0	0,6	11,9	16	6,5	0,6	0,6	10,3	12
M 8	11,1	1,1	0,6	15,5	20	8,5	0,6	0,5	11,5	12
M 10	13,5	1,2	0,6	18,3	20	-	-	-	-	-
M 12 - M16	17,1	1,4	0,6	22,2	25	-	-	-	-	-



Rivet Bushing serrated

Anchor®
Works Standard
701 0 to 718 0

Application

Anchor is a rivet bushing for captive, torque-resistant screw connections capable of withstanding loads from both sides in thin-walled workpieces (0.5 to 5 mm thickness)

The Anchor is suitable for thin-walled moulded components made of

- steel
- alloy
- NF metals and
- plastic

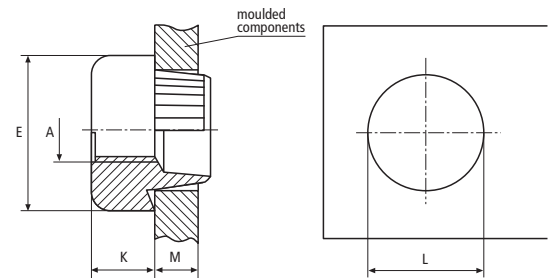

Dimensions in mm

Article no. of the first group of digits	for sheet metal thickness M	Article no. of the second and third group of digits	Internal thread A	External thread E	Nut height K	Recommended hole diameter	
						L a)	L b)
701	0,5 to 0,6 1)	... 000 020 ...	M 2	8,0	3,2	6,0	5,8
702	0,7 1)	... 000 025 ...	M 2,5	8,0	3,2	6,0	5,8
703	0,8 1)	... 000 030 ...	M 3	8,0	3,2	6,0	5,8
704	0,9 to 1,0 1)	... 000 035 ...	M 3,5	9,5	3,8	7,0	6,8
705	1,1 to 1,3 1)	... 000 040 ...	M 4	9,5	3,8	7,0	6,8
706	1,4 to 1,6 1)	... 000 050 ...	M 5	11,0	4,4	8,4	8,2
707	1,7 to 1,9 2)	... 000 060 ...	M 6	12,5	5,7	9,7	9,5
708	2,0 to 2,2 2)	... 000 080 ...	M 8	16,0	6,4	13,2	12,9
709	2,3 to 2,5 2)	... 000 100 ...	M 10	19,0	7,6	15,5	15,3
710	2,6 to 2,8 2)	... 000 120 ...	M 12	25,4	10,2	19,6	19,3
711	2,9 to 3,1 2)	... 000 140 ...	M 14	25,4	10,2	19,6	19,3
712	3,2 to 3,4 2)	... 000 160 ...	M 16	25,4	10,2	19,6	19,3
713	3,5 to 3,7 2)						
714	3,8 to 4,0 2)						
715	4,1 to 4,3 2)						
716	4,4 to 4,6 2)						
717	4,7 to 4,9 2)						
718	5,0 2)						

a) Reference value for normal applications

b) Reference value for extreme loads (torque / push-out forces) and for manual rivetting

The **first** group of digits is applicable for conventional rivetting; **for flush processing / stainless workpieces we recommend using shank lengths for the next smallest sheet metal thickness!**

1) Shoulder 20° undercut

2) Surfaced shoulder

Example for finding the article number

Serrated rivet bushing Anchor with internal thread M5 made of steel for sheet metal thickness 2 mm: Anchor 708 000 050.100

Materials

Steel unhardened, unrefined
Steel unhardened, galvanized, blue chromated
Steel unhardened, galvanized, yellow chromated
Rustproof material 1.4305
Light alloy
Brass

Article no. (**fourth** group of digits) 100
Article no. (**fourth** group of digits) 110
Article no. (**fourth** group of digits) 120
Article no. (**fourth** group of digits) 500
Article no. (**fourth** group of digits) 700
Article no. (**fourth** group of digits) 800

Other materials (e.g. steel, strength class 8) and versions (e.g. nut height or shank lengths for deviating sheet metal thicknesses) on request.

Tolerances

ISO 2768-m

Thread

Internal thread A: as per ISO 6H

Application

Anchor-Mini is a rivet bushing for captive, torque-resistant screw connections capable of withstanding loads from both sides in thin-walled workpieces (0.5 to 5 mm thickness)

made of
 - steel
 - alloy
 - NF metals and
 - plastic
 The Anchor-Mini is particularly weight and space-saving due to its minimal outside dimensions.

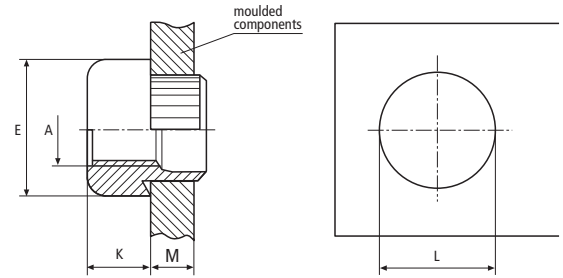

Dimensions in mm

Article no. of the first group of digits	for sheet metal thickness M	Article no. of the second and third group of digits	Internal thread A	External thread E	Nut height K	Recommended hole diameter L +0,05
721	0,5 to 0,6 1)	... 000 020 ...	M 2	5,0	2,3	3,5
722	0,7 1)	... 000 025 ...	M 2,5	5,5	2,8	4,2
723	0,8 1)	... 000 030 ...	M 3	5,5	2,8	4,2
724	0,9 to 1,0 1)	... 000 035 ...	M 3,5	7,0	3,2	5,5
725	1,1 to 1,3 1)	... 000 040 ...	M 4	7,0	3,2	5,5
726	1,4 to 1,6 1)	... 000 050 ...	M 5	8,5	3,8	6,5
727	1,7 to 1,9 2)	... 000 060 ...	M 6	10,0	5,1	7,7
728	2,0 to 2,2 2)	... 000 080 ...	M 8	12,0	6,5	9,7
729	2,3 to 2,5 2)					
730	2,6 to 2,8 2)					
731	2,9 to 3,1 2)					
732	3,2 to 3,4 2)					
733	3,5 to 3,7 2)					
734	3,8 to 4,0 2)					
735	4,1 to 4,3 2)					
736	4,4 to 4,6 2)					
737	4,7 to 4,9 2)					
738	5,0 2)					

For optimum strength values, installation using the tumble or radial rivetting process is recommended.

The **first** group of digits is applicable for conventional rivetting; **for flush processing (e.g. tumbling), we recommend using shank lengths for the next smallest sheet metal thickness!**

- 1) Shoulder 20° undercut
- 2) Surfaced shoulder

Example for finding the article number

Serrated rivet bushing Anchor with internal thread M5 made of steel for sheet metal thickness 2 mm: Anchor 728 000 050.100

Materials

Steel, unrefined
 Steel, galvanized, blue chromated
 Steel, galvanized, yellow chromated
 Rustproof material 1.4305
 Light alloy
 Brass

Article no. (**fourth** group of digits) 100
 Article no. (**fourth** group of digits) 110
 Article no. (**fourth** group of digits) 120
 Article no. (**fourth** group of digits) 500
 Article no. (**fourth** group of digits) 700
 Article no. (**fourth** group of digits) 800

Other materials and versions and finishing types on request

Tolerances

ISO 2768-m

Thread

Internal thread A: as per ISO 6H



Rivet Bushing serrated

Anchor®-Tanktyp
Works Standard
741 0 to 758 0

Application

Anchor-Tank Type is a rivet bushing with a threaded blind hole (sealed thread) for captive, torque-resistant screw connections in thin-walled workpieces. (0.5 to 5 mm thickness)

The Anchor is suitable for thin-walled moulded parts made of steel, light alloy, NF metal and plastic.

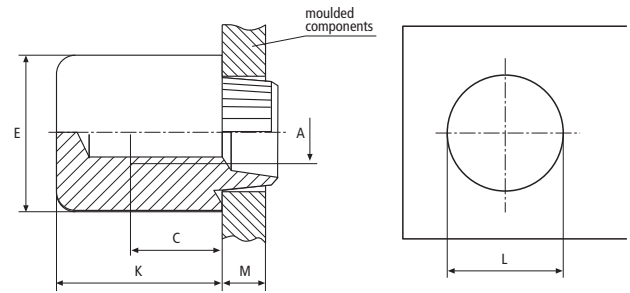

Dimensions in mm

Article no. of the first group of digits	for sheet metal thickness M	Article no. of the second and third group of digits	Internal thread A	External thread E	Nut height K	Recommended hole diameter		Thread depth min. C
						L a)	L b)	
741	0,5 to 0,6 1)	... 000 030 ...	M 3	8,0	8,5	6,0	5,8	3,0
742	0,7 1)	... 000 035 ...	M 3,5	9,5	9,0	7,0	6,8	4,0
743	0,8 1)	... 000 040 ...	M 4	9,5	9,0	7,0	6,8	4,0
744	0,9 to 1,0 1)	... 000 050 ...	M 5	11,0	10,0	8,4	8,2	5,0
745	1,1 to 1,3 1)	... 000 060 ...	M 6	12,5	10,5	9,7	9,5	5,5
746	1,4 to 1,6 1)	... 000 080 ...	M 8	16,0	12,0	13,2	12,9	5,5
747	1,7 to 1,9 2)	... 000 100 ...	M 10	19,0	13,5	15,5	15,2	6,0
748	2,0 to 2,2 2)	... 000 120 ...	M 12	25,4	19,0	19,6	19,3	7,0
749	2,3 to 2,5 2)							
750	2,6 to 2,8 2)							
751	2,9 to 3,1 2)							
752	3,2 to 3,4 2)							
753	3,5 to 3,7 2)							
754	3,8 to 4,0 2)							
755	4,1 to 4,3 2)							
756	4,4 to 4,6 2)							
757	4,7 to 4,9 2)							
758	5,0 2)							

- a) Reference value for normal applications
- b) Reference value for extreme loads (torque / push-out forces) and for manual rivetting

The **first** group of digits is applicable for conventional rivetting; **for flush processing (e.g. tumbling), we recommend using shank lengths for the next smallest sheet metal thickness!**

- 1) Shoulder 20° undercut
- 2) Surfaced shoulder

Example for finding the article number

Serrated rivet bushing Anchor Tank Type with internal thread M5 made of steel for sheet metal thickness 2 mm: Anchor Tank Type 748 000 050.100

Materials

Steel, unrefined
Steel, galvanized, blue chromated
Steel, galvanized, yellow chromated
Rustproof material 1.4305
Light alloy
Brass

Article no. (**fourth** group of digits) 100
Article no. (**fourth** group of digits) 110
Article no. (**fourth** group of digits) 120
Article no. (**fourth** group of digits) 500
Article no. (**fourth** group of digits) 700
Article no. (**fourth** group of digits) 800

Other materials and versions and finishing types on request (e.g. steel, strength 8).

Tolerances

ISO 2768-m

Thread

Internal thread A: as per ISO 6H

Clifa® press-in nut/stud ...

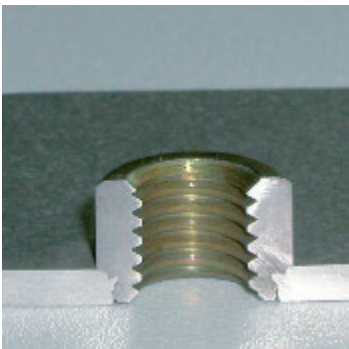

Clifa press-in nuts and Clifa studs are threaded inserts made of steel with a specially formed shank or head.

Clifa press-in nuts and Clifa studs can also be supplied in rust-proof material, and the nuts additionally in light alloy.

Clifa threaded inserts are pressed into moulded components with pre-punched receiving holes. During this process, the material flows out of the area of the hole wall into the gear ring / the annular grooves of the Clifa threaded inserts.
A permanent connection is formed.

Several Clifa inserts can be installed in a single work process. The fastening screw is always screwed in from the opposite side.



Fields of application

Clifa press-in nuts and Clifa studs are used to fasten all different types of appliance components, as spacers pins and bushings for plastics, e.g. circuit boards etc.

Product features

- Clifa is torque-proof, wear-resistant and capable of withstanding high loads
- It has minimal outside dimensions for space and weight-saving designs with an attractive appearance
- The thread is wear-resistant, clean and true to gauge
- Clifa is not pressed out during the screwing process
- For sheet metal thicknesses below 1.0 mm: Thin sheet metal press-in studs

Specifications

Works standard sheets Clifa
Pages 11 to 16

High-performance installation equipment for short cycle times in large-scale production on request.

Installation

The receiving hole is punched or drilled, but not deburred or countersunk.

With punched holes, Clifa is pressed in from the punching burr side. The press-in process takes place on a plane parallel basis using a customary press with adjustable pressure level, until the surface of the shoulder in the Clifa press-in nut comes to rest flat against the surface of the sheet metal.

In the case of the Clifa stud, the head must be fully embedded and come to rest flush with the surface of the sheet metal.

Pressure which is too high or applied only on one side as well as inclined support surfaces must be avoided wherever possible.

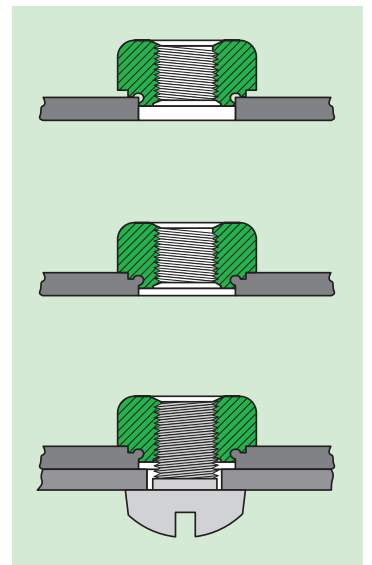



Press-in nut
self-clinching

Clifa®-M
Works Standard
500 0 to 503 0

Application

Clifa press-in nuts are used to create wear-free screw connections capable of withstanding high loads in thin-walled moulded components from 0.8 mm in thickness made of

- Steel
- Light alloy
- NF metal (up to hardness HRB 80)

The nut is anchored in the component as a result of the press-in process.

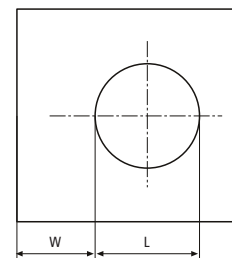
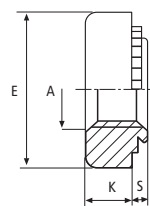

Dimensions in mm

	Article no. of the first group of digits	for sheet metal thickness	Shank height max.	Article no. of the second and third group of digits	Internal thread	External thread	Nut height	Hole dia.: Tolerance + 0.05	Minimum spacing
					A	E	K	L	W
M2 to M5	500	0,8 up to 1,0	0,7	... 000 020 ...	M 2	6,0	1,6	4,2	2,9
	501	1,1 up to 1,4	1,0	... 000 025 ...	M 2,5	6,0	1,6	4,2	2,9
	502	1,5 up to 2,3	1,3	... 000 030 ...	M 3	7,0	1,6	4,75	3,6
	503	from 2,4	2,2	... 000 040 ...	M 4	8,0	2,4	5,4	3,8
M6 and M8	500	1,0 up to 1,3	1,0	... 000 050 ...	M 5	9,0	2,4	6,35	3,8
	501	1,4 up to 2,3	1,35	... 000 060 ...	M 6	11,0	4,4	8,75	4,6
	502	2,4 up to 3,2	2,2	... 000 080 ...	M 8	12,5	6,0	10,5	4,8
	503	from 3,3	3,0	... 000 100 ...	M10	15,0	6,7	12,7	4,8
M10	501	2,4 up to 3,2	2,2						
	502	3,3 up to 6,3	3,0						
	503	from 6,4	6,0						

Example for finding the article number

Self-clinching press-in nut Clifa-M with internal thread M3 made of hardened, galvanized and chromated steel for sheet metal thickness 1.8 mm: Clifa-M 502 000 030.100

Materials

Steel, hardened, galvanized, yellow chromated
Rustproof material 1.4305
Light alloy

Article no. (**fourth** group of digits) 100
Article no. (**fourth** group of digits) 500
Article no. (**fourth** group of digits) 700

Other finishes or special shapes (e.g. spacer bushings) on request

Tolerances

ISO 2768-m

Thread

Internal thread A: as per ISO 6H

Press-in pressure as a guideline value for selection of the press

Clifa	For shaped parts made of
	Steel
M 2 / M 2,5	5 to 15 kN
M 3	5 to 17 kN
M 4	7 to 20 kN
M 5	7 to 25 kN
M 6	15 to 37 kN
M 8	17 to 40 kN
M 10	20 to 50 kN

The optimum press-in pressure must be determined by trial and error. In the case of light alloys, depending on the alloy composition and surface properties, higher press-in pressure levels may be necessary. Maximum retention is achieved when adhering precisely to the recommended hole diameter and tolerances.

Application

Clifa press-in nuts/spacer bushings are used to create wear-free screw connections capable of withstanding high loads in thin-walled moulded components from 0.8 mm in thickness made of

- Steel
- Light alloy
- NF metal
(up to hardness HRB 80)

The nut is anchored in the component as a result of the press-in process.

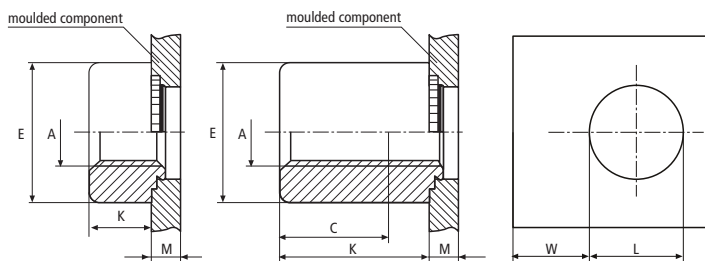

Dimensions in mm

Article no.	sheet metal thickness M	Internal thread A	External diameter E	Hole diameter L +0,05	Minimum spacing W
5.. 800 0.. ...	0,8 to 1,0	M 3	7,0	4,75	3,6
5.. 800 1.. ...	1,1 to 1,4	M 4	8,0	5,40	3,8
5.. 800 2.. ...	1,5 to 2,3	M 5	9,0	6,35	3,8
5.. 800 3.. ...	from 2,4				

Example for finding the article number

Self-clinching press-in nut Clifa-AM with internal thread M3, nut height 8.0 mm, made of hardened, galvanized and chromated steel for sheet metal thickness 1.8 mm: Clifa-AM 508 800 230.100

Nut height K available between 3.0 and 25 mm in 1.0 mm graduations

The second and third digit of the article number is used to identify the nut height K, the seventh digit for subdivision of the sheet metal thickness.

With nut heights > 8.0 mm, the usable thread length remains C 7.5 mm

Materials

Steel, hardened, galvanized, yellow chromated
Rustproof material 1.4305
Light alloy

Article no. (**fourth** group of digits) 100
Article no. (**fourth** group of digits) 500
Article no. (**fourth** group of digits) 700

Other finishes or special shapes on request

Tolerances

ISO 2768-m

Thread

Internal thread A: as per ISO 6H



Press-in nut / spacer bushing
for plastics

Clifa®-AL
Works Standard
503 6 to 525 6

Application

These Clifa press-in nuts are particularly suited for creating torque-resistant screw connections capable of withstanding high loads in thin-walled moulded parts from 1.5 mm in thickness.

- Epoxy glass fibre
 - Phenolic resin
 - Fibreglass (e.g. printing plates)
- Also suitable for aluminium and magnesium

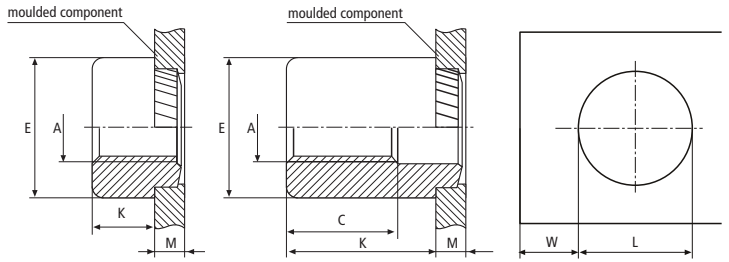

Dimensions in mm

Article no.	Internal thread	External thread	Workpiece thickness min.	Hole diameter: Tolerance + 0.1	Minimum spacing
	A	E	M	L	W
5.. 600 020 ...	M 2	6,0	1,5	3,7	2,2
5.. 600 025 ...	M 2,5	6,0	1,5	4,2	2,4
5.. 600 030 ...	M 3	7,0	1,5	4,2	2,4
5.. 600 040 ...	M 4	8,0	1,5	6,4	3,3
5.. 600 050 ...	M 5	9,0	1,5	6,8	4,1

Example for finding the article number

Diagonally serrated press-in nut Clifa AL with internal thread M3, nut height 8.0 mm, made of hardened, tinned steel: Clifa-AL 508 600 030.100

Nut height K available between 3.0 and 25 mm in 1.0 mm graduations

The second and third digit of the article number is used to identify the nut height K. With nut heights > 9.0 mm, the usable thread length remains C 9.0 mm

Materials

Steel, hardened, tinned
Rustproof material 1.4305

Article no. (**fourth** group of digits) 100
Article no. (**fourth** group of digits) 500

Other finishes on request

Tolerances

ISO 2768-m

Thread

Internal thread A: as per ISO 6H

Application

These Clifa press-in studs are particularly suited for creating torque-resistant screw connections capable of withstanding high loads in thin-walled moulded parts from 1.0 mm in thickness made of

- Steel
- Stainless steel
- Brass
- Copper
- Light alloy etc.

The stud is anchored in the component by the serrations as a result of the press-in process.

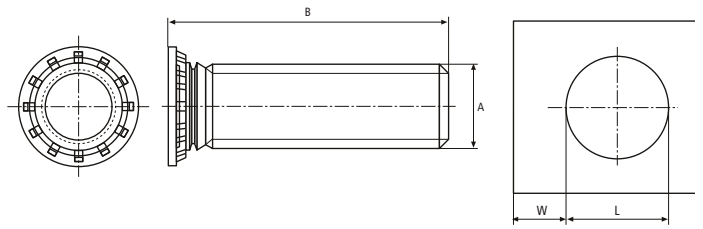

Dimensions in mm

Article no. first group of digits (selection series)	Length B	Available					
		M2,5	M3	M4	M5	M6	M8
506	6,0	x	x	x	x		
508	8,0	x	x	x	x	x	
510	10,0	x	x	x	x	x	x
512	12,0	x	x	x	x	x	x
515	15,0	x	x	x	x	x	x
518	18,0	x	x	x	x	x	x
520	20,0	x	x	x	x	x	x
.
.
.
534	34,0			x	x	x	x

Article no. second and third group of digits	Thread A	for sheet metal thickness ≥	Hole dia. tolerance +0.05 L	Minimum spacing ≥ W	Tightening torque of the nut ≤ Nm
... .00 025 ...	M 2,5	1,0	2,5	3,5	0,4
... .00 030 ...	M 3	1,0	3,0	4,0	0,8
... .00 040 ...	M 4	1,0	4,0	5,0	1,9
... .00 050 ...	M 5	1,0	5,0	5,0	3,8
... .00 060 ...	M 6	1,5	6,0	5,0	8,0
... .00 080 ...	M 8	1,5	8,0	6,0	12,0

Other lengths on request

Example for finding the article number

Self-clinching press-in stud Clifa-SP, M3 in steel, galvanized and chromated, 10 mm long, with serrations at the head for sheet metal thickness 1.2 mm: Clifa-SP 510 000 030.100

Standard
For lower strength fixture
For sheet metal under 1.0 mm

Coarse serration at the head
Fine serration at the head
Thin-metal press-in stud

Article no. 5.. 000
Article no. 5.. 100
Article no. 5.. 200

Materials

Steel, tempered, galvanized, yellow chromated
Rustproof material 1.4305

Article no. (**fourth** group of digits) 100
Article no. (**fourth** group of digits) 500

Tolerances

ISO 2768-m, length tolerance +/- 0.4 mm

Thread

Stud thread A: as per ISO 6g, imperial thread available in all customary sizes

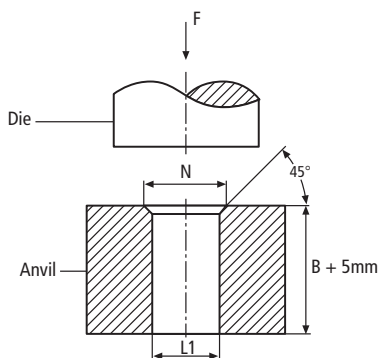

Dimensions in mm

Anvil for Clifa	Hole L ₁	Countersink for serrations N	Press-in pressure kN
M 2,5	2,6	3,4	8,9 to 12
M 3	3,1	4,0	10,5 to 19
M 4	4,1	5,2	16 to 25
M 5	5,1	6,4	29 to 30
M 6	6,1	7,6	30 to 50
M 8	8,1	10,2	30 to 60

The press-in pressure F is dependent on the Clifa dimension, the material and the thickness of the shaped component and also the type of serration at the head. The Clifa head must be fully embedded and must come to rest flush with the surface of the sheet metal. Excessive force must be avoided. For guideline values on the choice of press, see Clifa-M works standard 500 0 to 503 0. The hole diameter of the part to be screwed on ≈ A+0.6 mm. **Press-in studs Clifa-SPS with special external thread P=1.6 for retaining special fastening elements** (e.g. sheet metal nuts, cable clips etc.) **available on request.**



Press-in stud
for plastics

Clifa®-SL
Works Standard
506 7 to 518 7

Application

These Clifa press-in studs with diagonal serrations are particularly suited for creating torque-resistant screw connections capable of withstanding high loads in thin-walled moulded parts from 1.5 mm in thickness.

- Epoxy glass fibre
- Phenolic resin
- Fibreglass (e.g. printing plates)

Also suitable for aluminium and magnesium.

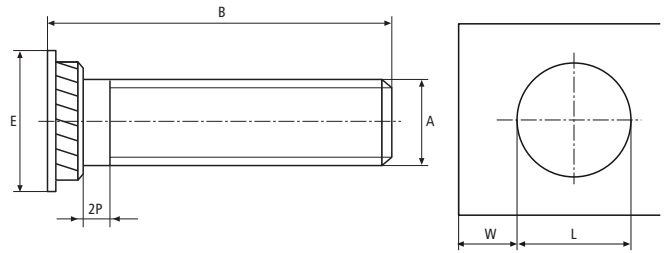

Dimensions in mm

Article no.	Thread	Length	Head diameter	Workpiece thickness min.	Hole dia. Tolerance +0,1	Minimum wall thickness
	A	B	E	M	L	W
5.. 700 030 ...	M 3	6,0 to 16,0	6,0	1,5	4,2	2,4
5.. 700 040 ...	M 4	6,0 to 16,0	7,0	1,5	6,4	3,3
5.. 700 050 ...	M 5	10,0 to 18,0	8,0	1,5	6,4	3,3

Example for finding the article number

Diagonally serrated press-in stud Clifa SL, M3, length B = 10.0 mm, made of hardened, tinned steel: Clifa-SL 510 700 030.100

Stud length from 6.0 mm to 18.0 mm available in graduations of 1.0 mm

The second and third digit of the article number is used to identify the length.

Materials

Steel, hardened, tinned
Rustproof material 1.4305

Article no. (**fourth** group of digits) 100
Article no. (**fourth** group of digits) 500

Other dimensions and materials on request

Tolerances

ISO 2768-m

Thread

Stud thread A: as per ISO 6g
Imperial thread available in customary sizes

Application

Clifa press-in studs are used to create wear-free screw connections capable of withstanding high loads in thin-walled moulded components.

The reinforced head shape permits higher loading capacity to be achieved.

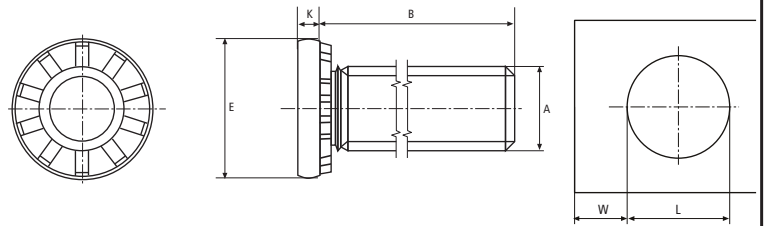

Dimensions in mm

Article no. of the first group of digits	Length ± 0,4 B*)	Preferred size					Article no. of the second and third group of digits	Thread A	Head dia. E	Head height ± 0,2 K	Hole dia. +0,1 L	Minimum spacing W	Tightening M _D Nm
		M4	M5	M6	M8	M10							
515	15	x	x	x	x		... 400 040 ...	M 4	7,5	1,2	4	9,5	2,9
520	20	x	x	x	x	x	... 400 050 ...	M 5	8,5	1,5	5	10,5	6,0
525	25	x	x	x	x	x	... 400 060 ...	M 6	10	1,5	6	11,5	10
530	30	x	x	x	x	x	... 400 080 ...	M 8	12,5	1,75	8	12,5	25
534	34	x	x	x	x	x	... 400 100 ...	M10	15,7	2,2	10	13,5	36

Example for finding the article number

Press-in stud Clifa-SA, M5 made of galvanized yellow chromated steel
20 mm long: Clifa-SA 520 400 050.100

Materials

Steel tempered, galvanized, yellow chromated

Article no. 100

Other materials on request

Tolerances

ISO 2768-m

Thread

Stud thread A: as per ISO 6g
Other dimensions on request.

***) Length B:**

available up to 60 mm

Press-in stud with several dog points on request.
See enquiry data sheet on next page.

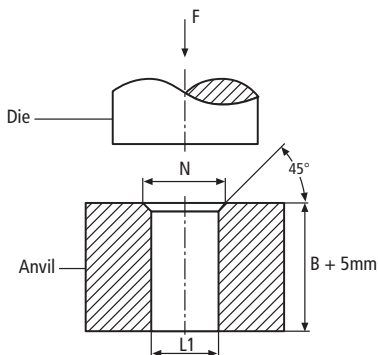

Dimensions in mm

Anvil for Clifa	Hole L ₁	Countersink for serrations N	Press-in pressure kN
M 4	4,1	5,2	14,5 to 38
M 5	5,1	6,4	21 to 42
M 6	6,1	7,6	21 to 50
M 8	8,1	10,2	21 to 60
M10	10,1	12,2	32 to 84

The press-in pressure F is dependent on the Clifa dimension, the material and the thickness of the shaped component and also the type of serration at the head. Excessive force must be avoided. The hole diameter of the part to be screwed on ≈ A+0.6 mm.



Enquiry data sheet
Press-in stud Clifa®-SA
 - select type of partend -

Fax to KerbKonus
 ++49 96 21 - 67 94 44

Enquiry from: _____
 Project: _____
 Contact: _____
 Company: _____
 Mr. / Mrs: _____
 Tel: _____
 Fax: _____
 Piece no.: _____

Enquiry no.: _____
 Project no.: _____
 Contact: _____
 KerbKonus: _____
 Mr. / Mrs.: _____
 Tel.: _____
 Fax: _____
 Quotation submitted on: _____
 Initial sample on: _____
 Pilot series on: _____
 Series start on: _____

We require a quotation
 samples
 technical advice

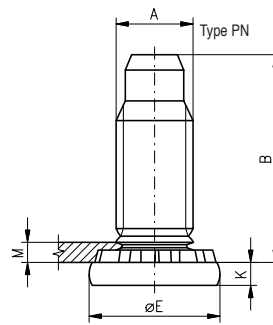
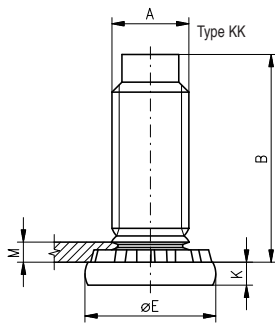
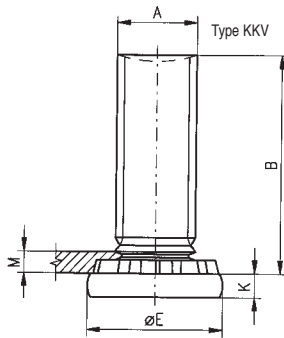

Please enter your requirements here:

Dimensions in mm					Type			Refinement				Sheet metal / moulded components	
A	E	K	B	M	KKV	KK	PN	Bright	Yellow	Blue	Layer thick-ness µm	Material	Material

_____ Date / Signature

Please separate at the perforated line and fax or mail to KerbKonus

Economical processing ...

Using follow-on composite tools, press-in studs and press-in nuts can be economically fastened to sheet metal components.

Using special sorting and conveying systems, the connecting elements are correctly positioned and guided towards the installation tool in the press. They are then inserted in the moulded component cyclically in time with the stroke of the press.

Whether processing by means of conventional assembly (using a press or tumble rivetting process) or with follow-on composite tools, the benefits offered by these connecting elements are evident:

- They can be used in pre-coated moulded components.
- They can be used in materials which are difficult or impossible to weld.
- No reworking is required at the thread.
- No heat influence whatsoever is exerted on the moulded components.
- They can be precisely positioned.
- They can be subjected to loads from both sides.



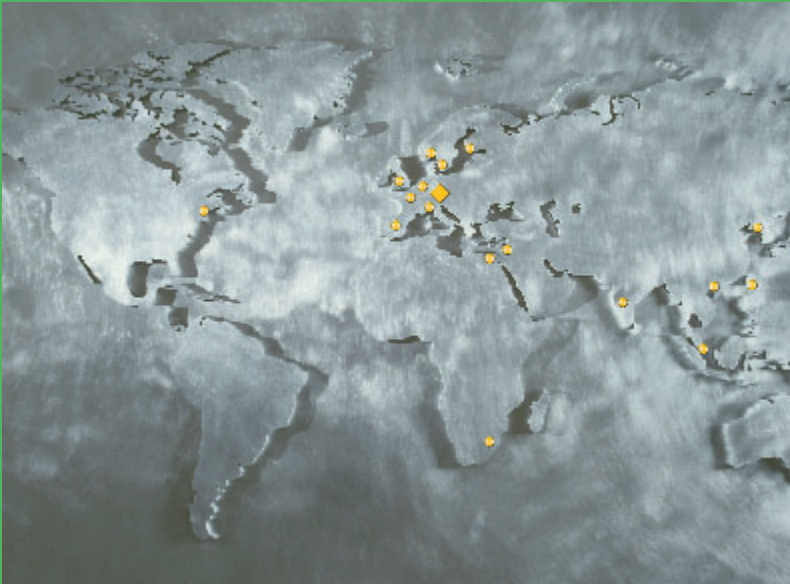

KerbKonus - Close to its customers. Around the world. Across every sector of industry.

First and foremost, for you customer proximity means a rapid response to your requirements and the fast, efficient realisation of the right fastening solution for you.

For us, customer proximity is far more than just another watchword - it is an important strategic instrument. Our technical sales consultants are available locally to talk to you around the world, ready to offer sound advice when it comes to the reliable, economical application of modern fastening technology. Advisory activities are coordinated through the headquarters in Amberg.

Why not simply call us to arrange an appointment?

Kerb-Konus-Vertriebs-GmbH

P.O.Box 16 63
D-92206 Amberg

Phone ++49 9621 679-0
Fax ++49 9621 679444
e-mail KKV-Amberg@kerbkonus.de

internet www.kerbkonus.de

... in Germany

Amberg Headquarters

Kerb-Konus-Vertriebs-GmbH
Werner-von-Braun-Straße 7
D-92224 Amberg

Production and Sales Hadamar

... and around the world

**Kerb-Konus
Fasteners Pvt. Ltd.**
Kolhapur/India

KKV Corp.
Osaka/Japan

KKV AG
Sattel/Switzerland

Precision Fasteners Inc.
Flanders, New Jersey/USA

Kerb-Konus Italia s.r.l.
Mulazzano/Italien

Kerb-Konus UK
Telford/Shropshire
UK

Kerb Konus Espanola S. A.
Alcorcon/Madrid
Spain

KKV Belgium
Gooik/Belgium

Sofrafix
Savigny-le-Temple
France

Other foreign agents in a wide number of countries.
Addresses on request or under www.kerbkonus.de

