

Threaded inserts for metal

Ensat®
Gripp®
Mubux®-Z
Mubux®-M

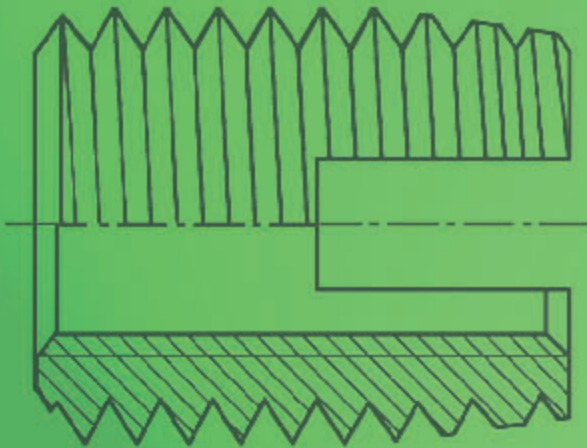



Fastening technology from KerbKonus is in successful application in a wide variety of different industrial sectors around the world.

State-of-the-art production facilities provide our customers with the assurance of quality and reliable delivery, and sophisticated fastening solutions for every conceivable field of application are implemented by our own Research and Development Department.

Close cooperation and exchange of experience and expertise on an international level ensure that our company stays at the cutting edge of technological development.

With independent branches and agencies operating in a number of countries around the world we are a truly reliable partner when it comes to secure fastening technology.

... our products and services

Depending on the required anchoring method in the material, KerbKonus offers a variety of threaded insert options:

- self-tapping threaded inserts for metal, wood and plastics,
- Threaded inserts for cold embedding
- Threaded inserts for hot or ultrasound embedding
- Threaded inserts for screwing into an internal thread
- Threaded inserts for riveting

Alongside its long-standing, proven spectrum of threaded inserts for a wide variety of applications, KerbKonus also offers a range of fastening technology-related products and services:

- Punched rivet system for thin mouldings
- Screw locking
- Thread sealing systems
- Insulating plastic coating

If you have a specific problem related to the field of fastening technology - with its rich fund of expertise and comprehensive product range, KerbKonus has the solution for you.

Technical details on KerbKonus products are also provided on our homepage: www.kerbkonus.de

Kerb-Konus-Vertriebs-GmbH

Werner-von-Braun-Straße 7
Industriegebiet Nord

D-92224 Amberg

Phone +49 9621 679-0
Fax +49 9621 679444
e-mail KKV-Amberg@kerbkonus.de

Internet www.kerbkonus.de



Dimensions Product features Retaining hole Pull-out strength Specifications Other details

Threaded inserts from KerbKonus ...

Tested quality; Test methods
 Ensat - the self-tapping threaded insert; Pull-out strength; Installation

Page 2 and 3
 Page 4 to 6

Ensats®-S 302 and Ensats®-SK 302 1



M2 to M30	self-tapping with cutting slot	Form cast or drilled	very high	Works Standard 302	Page 7 and 8
M4 to M10	/ and head			Works Standard 302 1	Page 9

Ensats®-SB 307/308 and Ensats®-SBK 307 1/308 1



M3 to M16	self-tapping with 3 cutting bores	Form cast or drilled	very high	Works Standard 307/308	Page 10
M5 to M10	/ and head			Works Standard 307 1/308 1	Page 11

Ensats®-SBN 317/318



M4 to M16	self-tapping with 3 bores and safety groove nut, grooved stud as a locking element	Form cast or drilled	very high	Works Standard 317/318	Page 12
-----------	--	----------------------	-----------	------------------------	---------

Ensats®-SBS 337/338 and Ensats®-SBT 357/358



M3 to M16	self-tapping with 3 cutting bores as chip reservoirs Tank version additionally with closed floor	Form cast or drilled	very high	Works Standard 337/338 Works Standard 357/358	Page 13
-----------	---	----------------------	-----------	--	---------

Ensats®-SD/SBD 303/347/348



M3 to M10 and M3.5 to M16	as 302/307/308 but in a special thin-walled version	Form cast or drilled	high	Works Standard 303 Works Standard 347/348	Page 14
------------------------------	---	----------------------	------	--	---------

Ensats®-SI 302 2 and Ensats®-SBI 307 2/308 2



M4 to M12	self-tapping with cutting slot or with 3 cutting bores and hexagonal socket	Form cast or drilled	very high	Works Standard 307 2 Works Standard 308 2	Page 15
-----------	---	----------------------	-----------	--	---------

Mubux®-Z 890



M4 and M5	Threaded inserts for embedding	Form cast or drilled	medium	Works Standard 890/896	Page 16
-----------	--------------------------------	----------------------	--------	------------------------	---------

Mubux®-M0 970



M3 to M12	Outside coated with precote 80 for anti-rotation and sealing	drilled and tapped thread (standard thread)	high	Works Standard 970	Page 17 and 18
-----------	--	---	------	--------------------	----------------

Ensats® Gripp 304



M14x1.25/9mm M14x1.25/15mm M18x1.5/9mm	drilled for spark plugs Retaining thread, self-tapping, with cutting bore		very high	Works Standard 304	Page 19 and 20
--	--	--	-----------	--------------------	----------------

Installation tools ...

Tools 620 / 621 / 610 / 6102

Page 21

Ensats installation ...

Manual installation
 Machine installation

Page 22
 Page 23

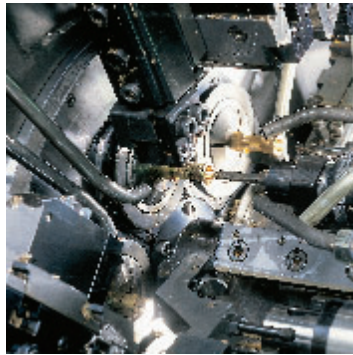
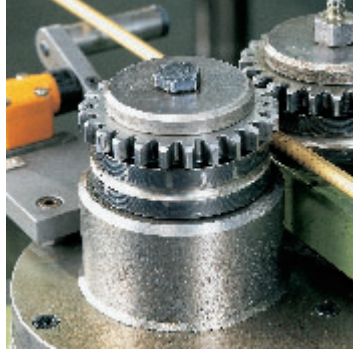

At our parent plant in Amberg, we produce threaded inserts using efficient production methods. A team of qualified and highly motivated staff guarantees a consistent, high standard of production.

The number of products manufactured over the company's history reaches into the billions. State-of-the-art automation lines manufacture around the clock in a precise and high standard of quality. The efficient and low-cost production of large-scale product series is one of the strengths on which we have based our success.

But our high-volume production output in no way compromises flexibility. We are able to quickly and efficiently produce even small batches of non-standard items.

Our state of the art stock control system permits the reliable, prompt delivery of standard products, keeping your production running to schedule at all times and helping to minimize your warehousing costs.

We are particularly proud of a cost-to-performance ratio which ensures satisfied customers the world over. This has made KerbKonus a reputable and respected partner to industry in the global marketplace.

Quality is a top priority issue at KerbKonus. Quality consciousness is a continuous thread running through every aspect of the company's work and all its products and services. Quality is lived and breathed at KerbKonus.

All the most important certifications and approvals are always kept consistently up to date, and our company is audited regularly for compliance with the most important international standards.

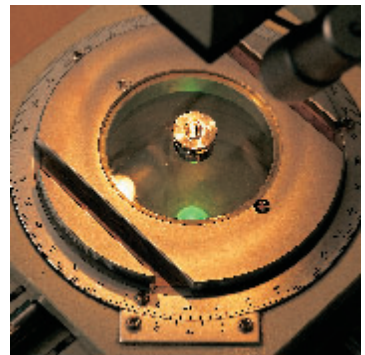
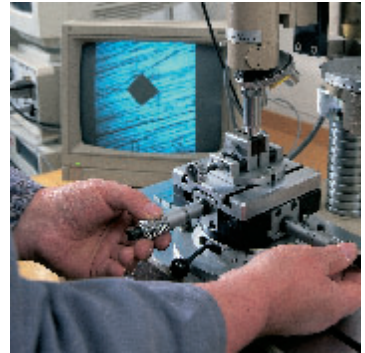

What really counts: tested quality.



Quality System
DQS Certificate in accordance with
DIN EN ISO 9001:2000 Reg. no. 001743 QM
ISO/TS 16949:2002 Reg. no. 001743 TS2/78

Applications on the test stand ...



Threaded inserts from KerbKonus are manufactured in large piece numbers. And human lives and safety can often depend upon just these tiny components, for instance in the case of air-bag retaining fasteners.

Because we bear this heavy responsibility, our products are tested and monitored in line with the most stringent directives. In the case of particularly critical applications, each and every part is exhaustively tested on state-of-the-art test equipment before it is delivered to you.

Test methods

The loading capacity of a thread depends in the main on the surface shell of the component which is exposed to shearing stress. By selecting just the right threaded insert for each application, maximum reliability can be achieved.

Using tried and tested, practically oriented test methods (see the table below), we provide the designer with a set of reliable specifications to ensure safe, reliable compliance with any application requirement, however unusual. In most cases, this can even be achieved using standard threaded inserts.

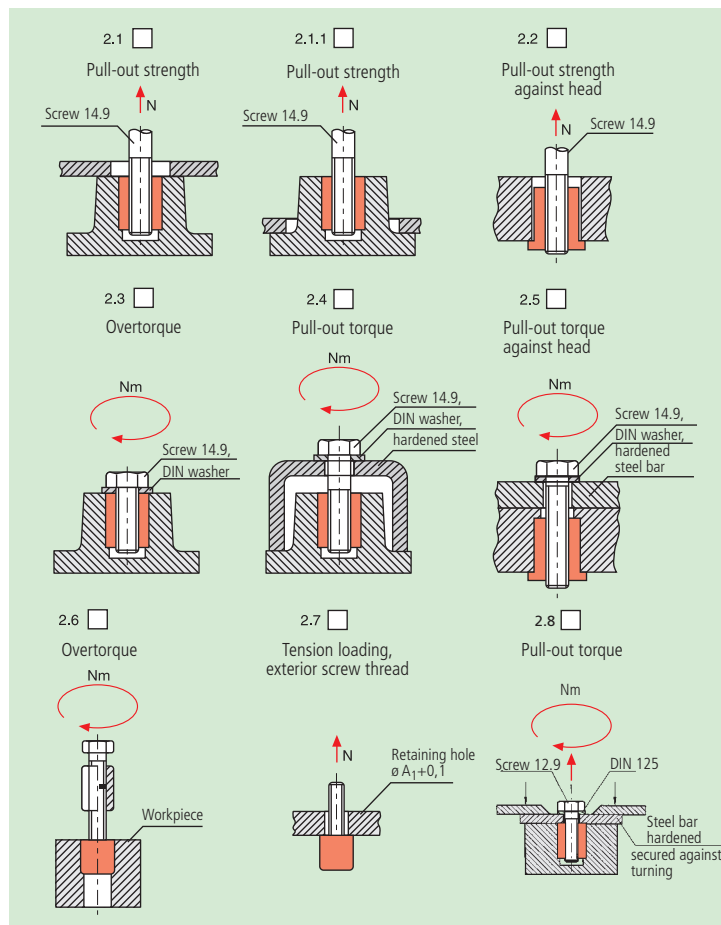

The Ensat® self-tapping threaded insert ...

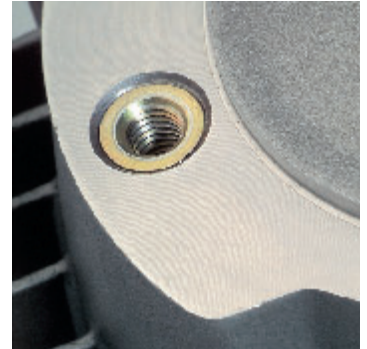

Ensats are self-tapping threaded inserts with external and internal thread, cutting slots or cutting bores.

A continuous process of further development has brought about a number of major improvements to product characteristics. These inserts are protected by German and also foreign patents.

Ensats®-S 302

(with cutting slot) is recommended for most application cases. In certain materials, this Ensats demonstrates a minimal inward springing action, so creating a certain screw locking effect. If this effect is not required, we recommend using Ensats-SB 307/308.

Ensats®-SB 307/308

(with cutting bores) was developed for materials with difficult cutting properties. This insert has a thick wall and the cutting force is distributed over three cutting edges.

The short version Ensats 307 is particularly suitable where minimal material thicknesses are involved.

Thin-walled Ensats®

for applications involving special space conditions (residual wall thicknesses), and also suitable for driving using a thread tapping machine (same internal and external thread pitch).

Slot version: Works Standard 303

Three-hole version: Works Standard 347/348 (see page 14).

Ensats®-SBS 337/338

with three chip reservoirs. Used primarily wherever no chips may be permitted to occur during the tapping process (see page 13).

Ensats®-SBT

with closed floor for additional sealing from below.

Works Standard 357/358.

Dimensions: see Works Standard 337/338 (page 13).



Fields of application

The Ensats are used throughout the whole of the metal and plastics processing industry.

Automotive industry, passenger and commercial vehicles

Engines, transmissions, wide range of supply parts such as wing mirrors, radiators, bumpers etc.

Plant and equipment construction

Flange joints, construction equipment, oil burners etc.

Household appliance and office machinery production

Vacuum cleaners, cameras, sun lamps, drills etc.

Electrical and laboratory supplies

Capacitors, heavy current, radio and telecommunication systems, dental technology equipment.

Military applications

Tanks, aircraft etc.

Product features

- The Ensats have a large effective shearing surface ($E \pi B$), so ensuring a higher degree of pull-out strength, i.e. an Ensats M4 is often sufficient instead of a cut M5 thread (see page 5).
- The Ensats are driven subsequently into the finished workpiece. This means a higher casting machine output, no rejects due to incorrectly cast-in insert components, no moulding sand trapped in the thread.
- A pre-cast or pre-drilled retaining hole with normal tolerance requirements is sufficient for driving in the Ensats. The thread is always precisely positioned.
- The work steps required with wire inserts – thread tapping, breaking off trunnions etc. as well as costly wearing tools (special thread drills, limit plug gauges etc.) are not needed with the Ensats-system.
- The Ensats are insensitive to small areas of shrinkage. The Ensats-system prevents damage caused by torn threads.

The Ensat® – pull-out resistance due to flange cover ...

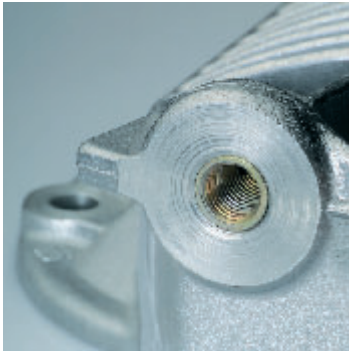

Connections using Ensat threaded inserts permit substantially smaller overall dimensions and thus pave the way for material-saving and weight-saving designs.

The illustration below shows two screw connections with equal pull-out strength.

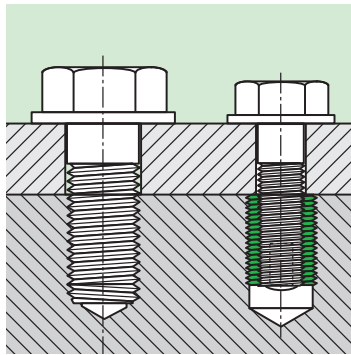

Flange cover

In a workpiece made of a light alloy, the Ensat 302 achieves almost maximum pull-out strength with only 30 % flange cover.

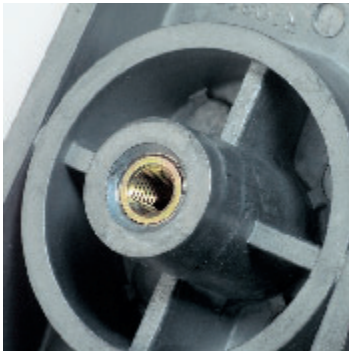

Pull-out strength

The Ensat is capable of withstanding high loads. When used in light alloys, for example, a degree of pull-out strength is achieved which far exceeds the yield strength of the mating screw 8.8.

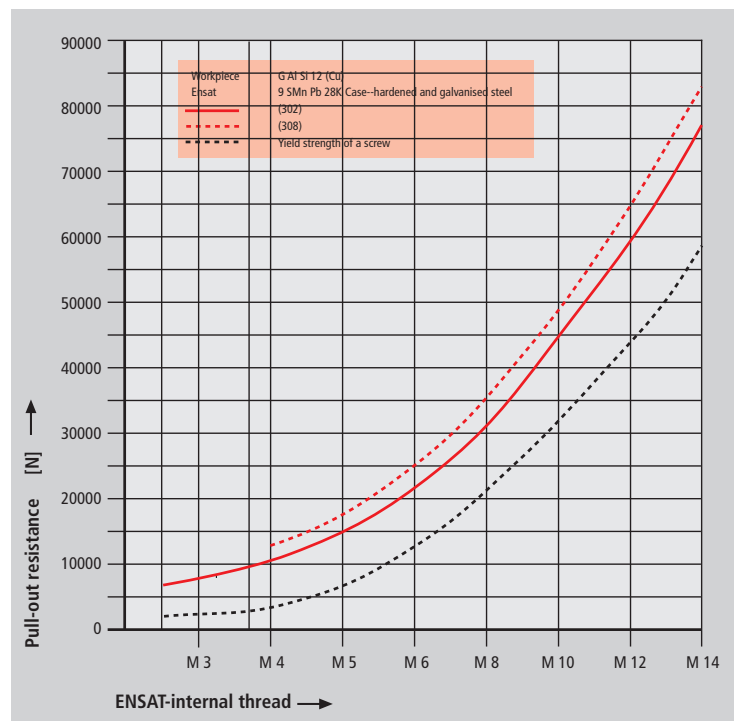
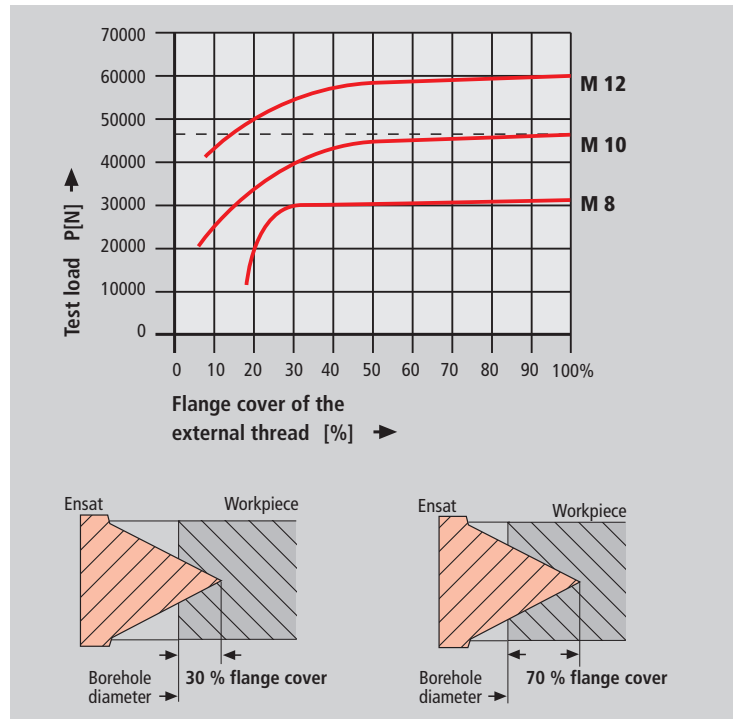

The Ensats[®] in the workpiece ...

Installation recommendation

Avoid any tilting between the Ensats and the screw – under the head or in the thread. For this reason, in the case of adjusting screws the Ensats is driven in to a depth of ≥ 1 mm. Studs are countersunk to the floor surface of the blind hole (see illustration).

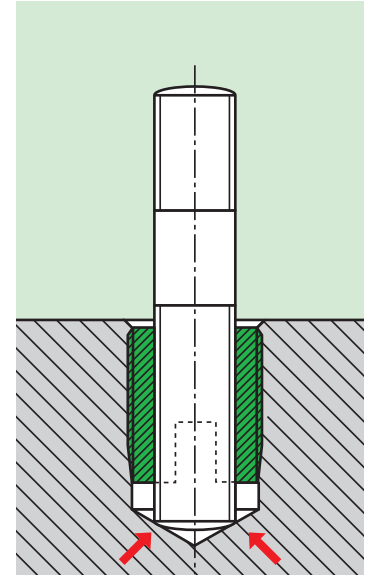

The adjacent table is used to determine the recommended bore hole diameter depending on the material of the workpiece and the Ensats type/dimension.

Example:

Light alloy workpiece ($R_m=280$ N/mm²), Internal thread M8, recommended bore hole diameter for **Ensats-S 302**: 11.2 to 11.4 mm **Ensats-S 307/308**: 11.2 to 11.5 mm

In case of processing problems (e.g. markedly increased screw-in torque levels) there is generally no harm in selecting diameter data in the next highest column. In case of doubt, we advise carrying out a test.

Borehole diameter [mm]		Standard values for ENSAT 302				Standard values for ENSAT 307/308 ... 337/338				
Workpiece material	Light alloys R_m =tensile strenght [N/mm ²]	$R_m < 250$	$R_m < 300$	$R_m < 350$	$R_m > 350$	$R_m < 300$	$R_m < 350$	$R_m > 350$		
	Ms, bronze, NF-metall									
	Cast iron HB = brinell hardness [N/mm ²]	< 150 HB	< 200 HB	> 200 HB		< 150 HB	< 200 HB	> 200 HB		
ENSAT internal thread	M2/M2,5 M3	Zoll N° 4	4,1 4,6	4,2 4,7	4,3 4,8	- 4,6	- 4,7	- 4,8		
	M3,5 M4	N° 6 N° 8	5,4 5,9	5,5 6,0	5,6 6,1	5,7 6,2	5,5 6,0	5,6 6,1	5,7 6,2	
	M5 M6(a)	N° 10 -	7,2 8,2	7,3 8,3	7,5 8,5	7,6 8,6	7,4 -	7,5 7,6	7,7 -	
	M6 M8	1/4 " 5/16 "	8,8 10,8	9,0 11,0	9,2 11,2	9,4 11,4	9,3 11,1	9,4 11,2	9,5 11,3	9,6 11,5
	M10 M12	3/8 " 7/16 "	12,8 14,8	13,0 15,0	13,2 15,2	13,4 15,4	13,1 15,0	13,2 15,1	13,3 15,2	13,5 15,4
	M14 M16	1/2 " 5/8 "	16,8 18,8	17,0 19,0	17,2 19,2	17,4 19,4	17,0 19,0	17,1 19,1	17,2 19,2	17,4 19,4
	M18 M20/22	- 3/4 "	20,8 24,8	21,0 25,0	21,2 25,2	21,4 25,4				
	M24 M27 M30		28,8 32,8 34,8	29,0 33,0 35,0	29,2 33,2 35,2	29,4 33,4 35,4				
	Flange cover approx.		60%	50%	40%	30%	80%	70%	60%	50%

Recommended borehole diameter for easy assembly. Other diameters may require lubrication.

These specifications are only recommendations and apply to ENSAT made of steel, hardened and plated.

Retaining hole

The retaining hole can be simply drilled or already provided for in the casting.

It is generally not necessary to countersink the hole. However, we do recommend that you take care not to warp the workpiece surface when screwing in the Ensats.

Material thickness:

Length of the Ensats = smallest admissible material thickness M.

Depth of the blind hole:

Minimum depth -T see Works Standard sheets, page 7 to 20.

Borehole diameter:

Brittle, tough and hard materials call for a larger borehole than soft or elastic materials. For guideline values, see the table above.

Edge distance:

The smallest still admissible edge distance depends on the planned stress level and the elasticity of the material into which the Ensats is screwed.

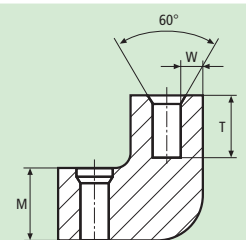

Guideline values for light alloys:

$W \geq 0.2$ to ≥ 0.6 E

Guideline values for cast iron:

$W \geq 0.3$ to ≥ 0.5 E

E = Outside diameter of the Ensats [mm]-



Threaded insert
self-tapping
metric inner thread

Ensats®-S
Works Standard
302

Application

The threaded insert with cutting slot is a self-tapping fastener for the creation of wear-free, vibration resistant screw joints with high loading capacity in materials with low shearing strength.

It is suitable for installation in the following materials:

- Light alloys
- Cast iron, brass, bronze
- NF metals
- Plastics, laminates
- Hardwoods

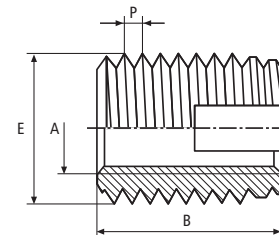

Dimensions in mm

Article no.	Internal thread		External thread		Length B	Minimum borehole depth for blind holes T
	A		E	P		
302 000 020 ...	M 2		4,5	0,5	6	8
302 000 025 ...	M 2,5		4,5	0,5	6	8
302 000 030 ...	M 3		5	0,5	6	8
302 000 035 ...	M 3,5		6	0,75	8	10
302 000 040 ...	M 4		6,5	0,75	8	10
302 000 050 ...	M 5		8	1	10	13
302 000 061 ...	M 6 (a)		9	1	12	15
302 000 060 ...	M 6		10	1,5	14	17
302 000 080 ...	M 8		12	1,5	15	18
302 000 100 ...	M 10		14	1,5	18	22
302 000 120 ...	M 12		16	1,5	22	26
302 000 140 ...	M 14		18	1,5	24	28
302 000 160 ...	M 16		20	1,5	22	27
302 000 180 ...	M 18		22	1,5	24	29
302 000 200 ...	M 20		26	1,5	27	32
302 000 220 ...	M 22		26	1,5	30	36
302 000 240 ...	M 24		30	1,5	30	36
302 000 270 ...	M 27		34	1,5	30	36
302 000 300 ...	M 30		36	1,5	40	46

Example for finding the article number

Self-tapping threaded insert Ensats-S of Works Standard series 302 with internal thread A = M5 made of steel, hardened, zinc-plated and yellow chromated: Ensats-S 302 000 050.160

Materials

- Unhardened steel
- Case-hardened steel, zinc-plated, yellow chromated
- Brass
- Rust-proof steel 1.4105
- Rust-proof steel 1.4305
- Other materials, designs and finishes on request.

- Article no. 100
- Article no. 160
- Article no. 800
- Article no. 400
- Article no. 500

Tolerances

ISO 2768-m

Thread

Internal thread A: as per ISO 6H
External thread E: metric, Tolerances in accordance with Works Standard
Internal thread UNC, UNF, Whitworth or fine threads see page 8.

For details of bore diameter guideline values, see the table on page 6

Please note

M2 / M2.5 are only suitable for low-strength materials, as the shear resistance of studs in the driving tools may be insufficient.

Application

Threaded insert with cutting slot and internal thread
Whitworth, UNC or UNF.

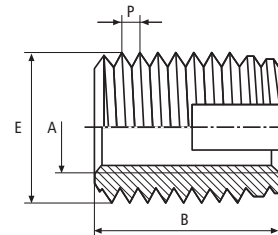

Dimensions in mm

	Article no.	Internal thread inch	External thread mm		Length mm	Minimum bore-hole depth for blind holes
			E	P		
Whitworth B.S.84 Internal thread Tolerance: medium	302 000 525 ...	1/4	10	1,5	14	17
	302 000 531 ...	5/16	12	1,5	15	18
	302 000 537 ...	3/8	14	1,5	18	22
	302 000 544 ...	7/16	16	1,5	22	26
	302 000 550 ...	1/2	18	1,5	22	26
	302 000 562 ...	5/8	20	1,5	22	27
UNC Unified Coarse Thread ANSI B1.1/BS 1580 Internal thread Tolerance 2B	302 000 604 ...	4 - 40	5	0,5	6	8
	302 000 606 ...	6 - 32	6	0,75	8	10
	302 000 608 ...	8 - 32	6,5	0,75	8	10
	302 000 610 ...	10 - 24	8	1	10	13
	302 000 625 ...	1/4 - 20	10	1,5	14	17
	302 000 631 ...	5/16 - 18	12	1,5	15	18
	302 000 637 ...	3/8 - 16	14	1,5	18	22
	302 000 644 ...	7/16 - 14	16	1,5	22	26
	302 000 650 ...	1/2 - 13	18	1,5	22	28
302 000 662 ...	5/8 - 11	20	1,5	22	27	
UNF Unified Fine Thread ANSI B1.1/B 1580 Internal thread Tolerance 2B	302 000 704 ...	4 - 48	5	0,5	6	8
	302 000 706 ...	6 - 40	6	0,75	8	10
	302 000 708 ...	8 - 36	6,5	0,75	8	10
	302 000 710 ...	10 - 32	8	1	10	13
	302 000 725 ...	1/4 - 28	10	1,5	14	17
	302 000 731 ...	5/16 - 24	12	1,5	15	18
	302 000 737 ...	3/8 - 24	14	1,5	18	22
	302 000 744 ...	7/16 - 20	16	1,5	22	26
	302 000 750 ...	1/2 - 20	18	1,5	22	28
	302 000 762 ...	5/8 - 18	20	1,5	22	27

Example for finding the article number

Self-tapping threaded insert Ensats-S from Works Standard series 302 with internal thread UNF 1/4"-28 made of hardened, zinc-plated and yellow chromated steel: Ensats-S 302 000 725.160

Materials

Unhardened steel
Case-hardened steel, zinc-plated, yellow chromated
Brass
Rust-proof steel 1.4105
Rust-proof steel 1.4305
Other materials, designs and finishes on request.

Article no. 100
Article no. 160
Article no. 800
Article no. 400
Article no. 500

Tolerances

ISO 2768-m

Thread

External thread E: metric, tolerances in accordance with Works Standard



Threaded insert
self-tapping

Ensats®-SK
Works Standard
302 1

Application

Threaded insert Ensats-SK 302 1 with cutting slot and head is a self-tapping fastener for the creation of wear-free, vibration-resistant screw joints with high loading capacity in materials with low shearing strength.

It is suitable for installation in the following materials:

- Light alloys
- Cast iron, brass, bronze, NF metals
- Plastics, laminates
- Hardwoods.

The head serves as a support for electrical contacts, for simultaneous fixture of several parts; when stress is applied against the head, the pull-through force is significantly increased.

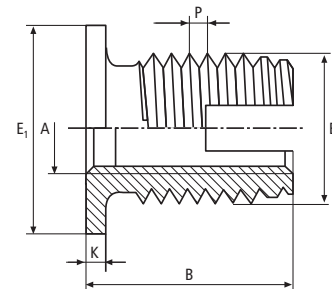

Dimensions in mm

Article no.	Internal thread	External thread		Head diameter	Head height	Length	Minimum borehole depth for blind holes
	A	E	P	E1	K	B	T
302 100 040 ...	M 4	6,5	0,75	9	1	9	10
302 100 050 ...	M 5	8	1	11	1	11	12
302 100 060 ...	M 6	10	1,5	13	1,5	15,5	16
302 100 080 ...	M 8	12	1,5	15	1,5	16,5	17
302 100 100 ...	M 10	14	1,5	17	1,5	19,5	20

Example for finding the article number

Self-tapping threaded insert Ensats-SK with head from Works Standard series 302 1 with internal thread A = M5 made of hardened, zinc-plated and yellow chromated steel: Ensats-SK 302 100 050.160

Materials

Unhardened steel
Case-hardened steel, zinc-plated, yellow chromated
Brass
Other materials, designs and finishes on request.

Article no. 100
Article no. 160
Article no. 800

Tolerances

ISO 2768-m

Thread

Internal thread A: as per ISO 6H
External thread E: metric, tolerances in accordance with Works Standard
Internal thread UNC, UNF, Whitworth or fine thread on request

For details of bore diameter guideline values, see the table on page 6

Application

Threaded insert Ensats-SB with cutting bores is a self-tapping fastener for the creation of wear-free, vibration resistant screw joints with high loading capacity in materials with low shearing strength.

It is suitable for installation in the following materials:

- Aluminium and aluminium alloys
- Magnesium alloys
- Duroplastics, thermoplastics (with the exception of rubber-soft thermoplastics < 100 Shore A)

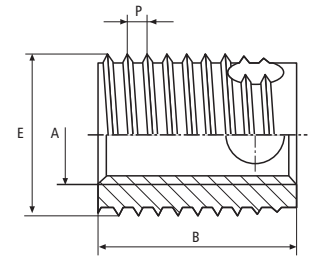

Dimensions in mm

Article no.	Internal thread A	External thread		Length B	Minimum borehole depth for blind holes T
		E	P		
307 000 030 ... 308 000 030 ...	M 3	5	0,6	4 6	6 8
307 000 035 ... 308 000 035 ...	M 3,5	6	0,8	5 8	7 10
307 000 040 ... 308 000 040 ...	M 4	6,5	0,8	6 8	8 10
307 000 050 ... 308 000 050 ...	M 5	8	1	7 10	9 13
307 000 060 ... 308 000 060 ...	M 6	10	1,25	8 12	10 15
307 000 080 ... 308 000 080 ...	M 8	12	1,5	9 14	11 17
307 000 100 ... 308 000 100 ...	M 10	14	1,5	10 18	13 22
307 000 120 ... 308 000 120 ...	M 12	16	1,75	12 22	15 26
307 000 140 ... 308 000 140 ...	M 14	18	2	14 24	17 28
307 000 160 ... 308 000 160 ...	M 16	20	2	14 24	17 28

Example for finding the article number

Self-tapping threaded insert Ensats-SB from Works Standard series 307 with internal thread A = M5 made of hardened, zinc-plated and yellow chromated steel: Ensats-SB 307 000 050.160

Short design Long design

Works Standard 307
Works Standard 308

Materials

Unhardened steel
Case-hardened steel, zinc-plated, yellow chromated
Rust-proof steel 1.4105
Rust-proof steel 1.4305
Brass
Other materials, designs and finishes on request.

Article no. 100
Article no. 160
Article no. 400
Article no. 500
Article no. 800

Tolerances

ISO 2768-m

Thread External thread E

Internal thread A: as per ISO 6H
Special thread with flattened thread root, tolerances in accordance with Works Standard
Internal thread UNC, UNF, Whitworth or fine thread on request

For details of bore diameter guideline values, see the table on page 6

Special applications

For chip-sensitive applications (e.g. electronic appliances): Also available **with 3 closed cutting bores serving as chip reservoirs**. Works Standard 337 / 338 - Page 13



Threaded insert
self-tapping

Ensat®-SBK
Works Standard
307 1 and 308 1

Application

Threaded insert Ensat-SBK with bores is a self-tapping fastener for the creation of wear-free, vibration resistant screw joints with high loading capacity in materials with low shearing strength.

It is suitable for installation in the following materials:
 - Aluminium and aluminium alloys
 - Magnesium alloys
 - Duroplastics, thermoplastics (with the exception of rubber-soft thermoplastics < 100 Shore A)

The head serves as a support for electrical contacts, for simultaneous fixture of several parts; when stress is applied against the head, the pull-through force is significantly increased.

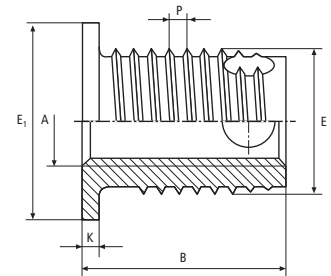

Dimensions in mm

Article no.	Internal thread	External thread		Head diameter E1	Head height K	Length B	Minimum borehole depth for blind holes T
	A	E	P				
307 100 050 ... 308 100 050 ...	M 5	8	1	11	1	8 11	9 13
307 100 060 ... 308 100 060 ...	M 6	10	1,25	13	1,5	9,5 13,5	10 15
307 100 080 ... 308 100 080 ...	M 8	12	1,5	15	1,5	10,5 15,5	11 17
307 100 100 ... 308 100 100 ...	M10	14	1,5	17	1,5	11,5 19,5	13 22

Example for finding the article number

Self-tapping threaded insert Ensat-SBK from Works Standard series 307 1 with internal thread A = M5 made of hardened, zinc-plated and yellow chromated steel: Ensat-SBK 307 100 050.160

Short design
Long design

Works Standard 307 1
Works Standard 308 1

Materials

Unhardened steel
Case-hardened steel, zinc-plated, yellow chromated
Brass
Other materials, designs and finishes on request.

Article no. 100
Article no. 160
Article no. 800

Tolerances

ISO 2768-m

Thread

Internal thread A: as per ISO 6H
External thread E: Special thread with flattened thread root, tolerances in accordance with Works Standard
Internal thread UNC, UNF, Whitworth or fine thread on request

For details of bore diameter guideline values, see the table on page 6

Special applications

For chip-sensitive applications (such as electronic appliances): Also available **with three closed cutting bores serving as chip reservoirs**. Works Standard 337 1 / 338 1.
Example: Ensat with head and closed cutting bores, internal thread M10, length 19.5 mm, case-hardened, zinc-plated, yellow chromated steel = Ensat-SBSK 338 100 100.160

Application

This special threaded insert is used to absorb extreme torsional and vibration stress. The anti-rotation function is achieved by means of a parallel notched stud to DIN 1473 (pre-drill with diameter E3, depth = B3+1mm).

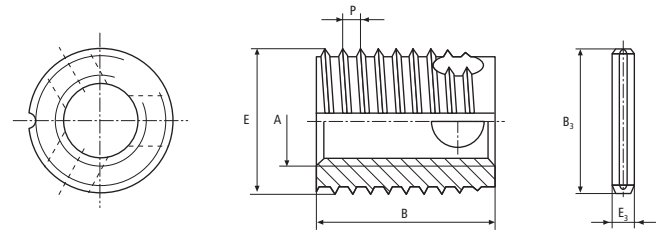

Dimensions in mm

Article no.	Internal thread A	External thread Special thread		Length		Notched stud	
		E	P	B	T	B ₃	E ₃
317 000 040 ... 318 000 040 ...	M 4	6,5	0,8	6 8	8 10	4 6	2 2
317 000 050 ... 318 000 050 ...	M 5	8	1	7 10	9 13	4 6	2 2
317 000 060 ... 318 000 060 ...	M 6	10	1,25	8 12	10 15	6 10	2 2
317 000 080 ... 318 000 080 ...	M 8	12	1,5	9 14	11 17	6 10	2 2
317 000 100 ... 318 000 100 ...	M 10	14	1,5	10 18	13 22	6 16	2 2
317 000 120 ... 318 000 120 ...	M 12	16	1,75	12 22	15 26	10 16	2 2
317 000 140 ... 318 000 140 ...	M 14	18	2	14 24	17 28	10 16	2 2
317 000 160 ... 318 000 160 ...	M 16	20	2	14 24	17 28	10 16	2 2

Example for finding the article number

Self-tapping threaded insert Ensats-SBN from Works Standard series 318 with safety groove and internal thread A = M5 made of hardened, zinc-plated and yellow chromated steel: Ensats-SBN 318 000 050.160

**Short design
Long design**

Works Standard 317
Works Standard 318

Materials

Case-hardened steel, zinc-plated, yellow chromated
On request:
Unhardened steel
Rustproof material 1.4105
Rustproof material 1.4305
Brass
Other materials, designs and finishes on request.

Article no. 160
Article no. 100
Article no. 400
Article no. 500
Article no. 800

Material of the notched stud: Steel 6.8 to DIN 267, zinc-plated.

Tolerances

ISO 2768-m

Thread

Internal thread A: as per ISO 6H
External thread E: Special thread with flattened thread root, tolerances in accordance with Works Standard
Internal thread UNC, UNF, Whitworth or fine thread on request.

For details of bore diameter guideline values, see the table on page 6



Threaded insert
self-tapping with chip reservoirs

Ensat®-SBS
Works Standard
337 and 338

Application

This special Ensat was developed primarily for applications in which chips - created by the self-tapping process - exert a detrimental effect and could cause serious damage or failure during

subsequent operation of the installed assembly - for example in electronic equipment. The three cutting bores distributed around the periphery are formed as chip reservoirs.

The chips created during the installation process are stored in these reservoirs and cannot drop into sensitive equipment components.

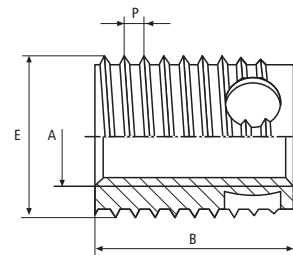

Dimensions in mm

Article no.	Internal thread A	External thread Special thread		Length B	Minimum borehole depth for blind holes T
		E	P		
337 000 030 ... 338 000 030 ...	M 3	5	0,6	4 6	6 8
337 000 035 ... 338 000 035 ...	M 3,5	6	0,8	5 8	7 10
337 000 040 ... 338 000 040 ...	M 4	6,5	0,8	6 8	8 10
337 000 050 ... 338 000 050 ...	M 5	8	1	7 10	9 13
337 000 060 ... 338 000 060 ...	M 6	10	1,25	8 12	10 15
337 000 080 ... 338 000 080 ...	M 8	12	1,5	9 14	11 17
337 000 100 ... 338 000 100 ...	M 10	14	1,5	10 18	13 22
337 000 120 ... 338 000 120 ...	M 12	16	1,75	12 22	15 26
337 000 140 ... 338 000 140 ...	M14	18	2	14 24	17 28
337 000 160 ... 338 000 160 ...	M 16	20	2	14 24	17 28

Example for finding the article number

Self-tapping threaded insert Ensat-SBS with chip reservoirs, from Works Standard series 338, B = 12 mm, with internal thread A = M6 made of rustproof material 1.4105: Ensat-SB 338 000 060.400

Short design
Long design

Works Standard 337
Works Standard 338

Materials

Unhardened steel
Case-hardened steel, zinc-plated, yellow chromated
Rust-proof steel 1.4105
Rust-proof steel 1.4305
Brass
Other materials, designs and finishes on request.

Article no. 100
Article no. 160
Article no. 400
Article no. 500
Article no. 800

Tolerances

ISO 2768-m

Thread

Internal thread A: as per ISO 6H
External thread E: Special thread with flattened thread root, tolerances in accordance with Works Standard
Internal thread UNC, UNF, Whitworth or fine thread on request.

Bore diameter

Due to the limited capacity volume of the chip reservoirs, select the largest bore diameter. For details of bore diameter guideline values, see the table on page 6

Special versions

For closed and sealed applications, available with chip reservoirs and closed floor (tank version from M4); Works Standard 357 / 358. Or with head from M5: Ensat-SBSK, Works Standard 337 1 / 338 1.

Application

Threaded insert Ensat with cutting slot or three cutting bores in a special thin-walled and shortened version. Particularly suitable for plastic with thin residual walls and for light-weight constructions.

These versions are designed primarily for processing on thread tapping machines, as the pitch of the outside and inside thread is identical. For processing thin-walled inserts in metal, the tensile strength / hardness of the

base material is always the determining factor. In critical cases, we recommend lubricating with suitable media in order to prevent fracture of the thin-walled inserts.

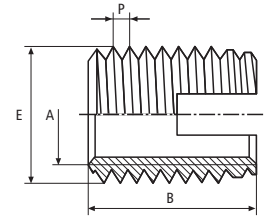

Dimensions in mm

Article no.	Internal thread	External thread		Length B	Location hole diameter, non-ductile alloys, NF metals		Minimum borehole depth for blind holes	
	A	E	P		L		T	
303 000 030 ...	M 3	4,5	0,5	6	4,2	bis 4,3	8	
303 000 035 ...	M 3,5	5	0,6	6	4,7	bis 4,8	8	
303 000 040 ...	M 4	6	0,7	6	5,6	bis 5,7	8	
303 000 050 ...	M 5	7	0,8	8	6,6	bis 6,7	10	
303 000 060 ...	M 6	8	1,0	10	7,5	bis 7,6	13	
303 000 080 ...	M 8	10	1,25	12	9,2	bis 9,4	15	
303 000 100 ...	M 10	12	1,5	15	11,2	bis 11,4	18	

Example for finding the article number

Self-tapping thin-walled insert Ensat-SD slot from Works Standard series 303 with internal thread A = M5 made of hardened, zinc-plated and yellow chromated steel: Ensat-SD 303 000 050.160

Materials, tolerances, thread, see Works Standard 302, Page 7 and 8

Application

Threaded insert Ensat with three cutting slots in a special thin-walled or shortened version. Particularly suitable for plastic with thin residual walls and for light-weight constructions. This version is designed primarily for processing on thread tapping

machines, as the pitches of the external and internal threads are identical. For processing thin-walled inserts in metal, the tensile strength / hardness of the base material is always the determining factor. In critical cases we recommend lubricating

with suitable media in order to prevent fracture of the thin-walled inserts

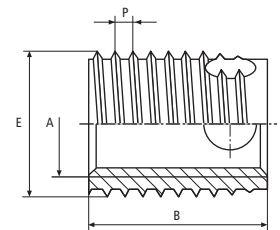

Dimensions in mm

Article no.	Internal thread A	External thread		Length B		Location hole diameter, non-ductile alloys, NF metals L	Minimum borehole depth for blind holes	
		E	P	Factory standard			Factory standard	
				347	348		B	B
3.. 000 035 ...	M 3,5	5	0,6	5	8	4,7 bis 4,8	7	10
3.. 000 040 ...	M 4	6	0,7	6	8	5,6 bis 5,7	8	10
3.. 000 050 ...	M 5	6,5	0,8	7	10	6,1 bis 6,2	9	13
3.. 000 060 ...	M 6	8	1	8	12	7,5 bis 7,7	10	15
3.. 000 080 ...	M 8	10	1,25	9	14	9,4 bis 9,6	11	17
3.. 000 100 ...	M 10	12	1,5	10	18	11,2 bis 11,5	13	22
3.. 000 120 ...	M 12	14	1,75	12	22	13,2 bis 13,5	15	26
3.. 000 140 ...	M 14	16	2	14	24	15,1 bis 15,4	17	28
3.. 000 160 ...	M 16	18	2	14	24	17,1 bis 17,4	17	28

Short design Works Standard 347

Long design Works Standard 348

Materials, tolerances, thread see Works Standard 307/308, Page 10



Threaded insert
self-tapping with hexagonal socket

Ensat®-SI/SBI
Works Standard
302 2 / 307 2 and 308 2

Application

This threaded insert with hexagonal socket is a self-tapping fastener for the creation of low-wear, vibration resistant screw joints with high load capacity in materials with low shearing strength. The Ensat is inserted via the hexagonal socket, permitting the achievement of short installation times. Other benefits: More simple driving tools and machines which require only clockwise rotation.

When using in plastics, the Ensat can be extracted without problems before the recycling process, resulting in lower costs. It is suitable for installation in the following materials:
 - Aluminium and aluminium alloys
 - Magnesium alloys
 - Duroplastics, thermoplastics (with the exception of rubber-soft thermoplastics < 100 Shore A)

Ensat SI 302 2

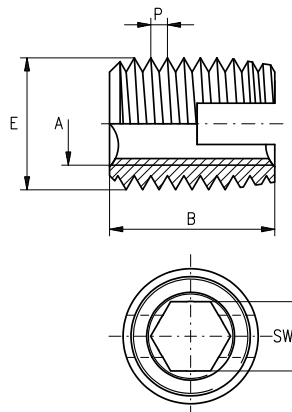

Ensat SBI 307 2 / 308 2

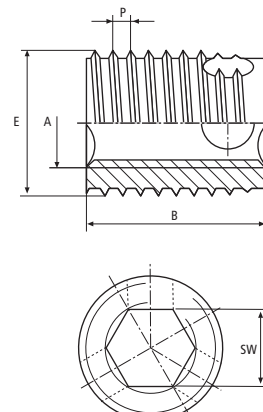

Dimensions in mm

Article no.	Internal thread	Special external thread		Length	Hexagonal socket	Minimum drill hole depth in case of blind holes	Minimum wall Thickness
	A	E	P				
302 200 040 ...	M 4	6,5	0,75	8	3,2	10	8
307 200 040 ...			0,8	6	3,2	8	6
308 200 040 ...			0,8	8	3,2	10	8
302 200 050 ...	M 5	8	1	10	4,1	13	10
307 200 050 ...			1	7	4,1	9	7
308 200 050 ...			1	10	4,1	13	10
302 200 060 ...	M 6	10	1,5	14	4,9	17	14
307 200 060 ...			1,25	8	4,9	11	8
308 200 060 ...			1,25	12	4,9	15	12
302 200 080 ...	M 8	12	1,5	15	6,6	18	15
307 200 080 ...			1,5	9	6,6	12	9
308 200 080 ...			1,5	14	6,6	17	14
302 200 100 ...	M 10	14	1,5	18	8,3	22	18
307 200 100 ...			1,5	10	8,3	16	10
308 200 100 ...			1,5	18	8,3	22	18
302 200 120 ...	M 12	16	1,5	22	10,1	27	22
307 200 120 ...			1,75	12	10,1	15	12
308 200 120 ...			1,75	22	10,1	26	22

Example for finding the article number

Self-tapping threaded insert Ensat-SBI from Works Standard series 308 2 with internal thread A = M 5 made of hardened, zinc-plated, yellow chromated steel: Ensat-SBI 308 200 050.160

Materials

Case-hardened steel, zinc-plated, yellow chromated
 Brass
 Other materials on request.

Article no. 160
 Article no. 800

Tolerance

ISO 2768-m

Thread

Internal thread A: as per ISO 6H
 External thread E: Special thread with flattened thread root, tolerance in accordance with Works Standard

For details of bore diameter guideline values, see the table on page 6

Mubux[®]-Z – press-in threaded inserts ...



Mubux-Z is a press-in threaded insert made of hardened and zinc-plated steel with helical annular around the outside.

Application range

For screw fasteners in cast components made of NF metal - primarily light alloy, for through holes and blind holes.

Mounting

Mubux-Z is simply pressed into a normal borehole. The retaining hole is drilled or provided for during the casting processes. Mubux-Z is inserted with the guiding shoulder pointing downwards into the borehole. The press die should be smooth (if applicable polished) in order not to impede the rotary movement of the Mubux-Z during the press-in process.

Product features

Wear-resistant, rustproof thread with sufficient pull-out strength. Fast, simple press-in without the use of special tools and without the need for a "thread tapping" process

Press-in threaded insert

Mubux[®]-Z
Works Standard
890

Application

For the creation of wear-resistant screw joints with high load capability in cast alloy components. Suitable for through holes and blind holes.

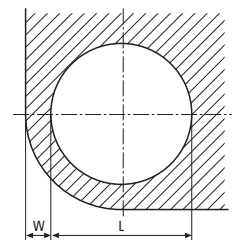
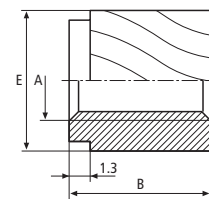

Dimensions in mm

Article no.	Internal thread	External-ø	Length	recommended retaining hole ¹⁾	Distance from edge ¹⁾
	A	E	B	L	W
890 000 040.100	M 4	7,7	6,9	7,2	2,4
890 000 050.100	M 5	7,7	6,9	7,2	2,4

¹⁾ Reference values only. Trials on the resp. materials are recommended.

Example for finding the article number

Press-in threaded insert Mubux-Z with internal thread A = M4 made of hardened, zinc-plated and yellow chromated steel: Mubux-Z 890 000 040.100

Material

Hardened, zinc-plated, yellow chromated steel

Thread

Internal thread: ISO 6H

Tolerances

ISO 2768m

Mubux[®]-MO – the coated threaded insert ...

Threaded insert Mubux-MO is made of zinc-plated steel, with internal and external threads. It is coated on the outside with precote 80.

Application range

Mubux-MO is used wherever a vibration-free firm fit and extremely good sealing properties are required in addition to a high thread load capacity and wear resistance. It is suitable for a wide range of different materials from plastic to steel, for minimal wall thicknesses and extremely brittle materials.

Product features

- Low installation costs
- Simple installation without the need for costly special tools
- Exchange of threaded inserts without tool damage

precote 80 coating

precote 80 is a microcapsule acrylic-based pre-coating. When screwed into a nut thread, the capsules break open and the plastic flux begins to harden. This creates a firm, water-tight joint. Hand-tight after approx. 20 minutes, full loading capability after three hours.

Other coating variants for screw locking and thread sealing are described in more detail in our publication no. 60.

Installation

1. Drill the retaining hole.
2. Tap the thread with a standard thread tap.
3. Screw in the MO with simple tools; either manually, semi-automatically or fully automatic.

All Ensaf driving tools and machines can also be used for Mubux-MO.

Installing under pre-tension increases the breakaway torque.

Important: The parts must be free of oil and grease prior to installation.



Application

For the creation of wear-resistant screw joints with good load capability in light alloy castings. Suitable for through holes and blind holes

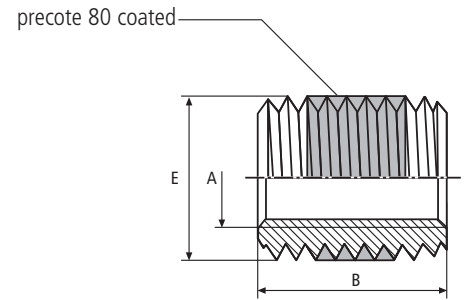

Dimensions in mm

Article no. first group of digits	Length ¹⁾
	B
971	1 A
972	1,5A
973	2 A
974	2,5A

Article no. second and third group of digits	Internal thread A	External thread E	Standard length ¹⁾ B			
			1A	1,5A	2A	2,5A
... 000 030 ...	M 3	M 5		4,5	6	
... 000 040 ...	M 4	M 6		6	8	10
... 000 050 ...	M 5	M 7		7,5	10	12,5
... 000 060 ...	M 6	M 8		9	12	15
... 000 080 ...	M 8	M 12		12	16	20
... 000 100 ...	M 10	M 14		15	20	25
... 000 120 ...	M 12	M 16	12	18	24	30

¹⁾ Tolerance ±0,25 mm

Example for finding the article number

Threaded insert Mubux-MO with internal thread A = M6, length B = 12 mm, made of zinc-plated and yellow chromated steel and coated with microcapsule-based adhesive precote 80: Mubux-MO 973 000 060.100

Material

Zinc-plated and yellow chromated steel; coated with precote 80
Zinc-plated and yellow chromated steel; without coating
Other materials on request.

Article no. 100
Article no. 120

Thread

Internal thread A: ISO 6H
External thread E: capable of being screwed into a standard thread.

Coating

Microcapsule pre-coating on an acrylic basis precote 80, maximum storage capability 4 years at room temperature.

Recommended length

Workpiece shear strength N/mm ²	Tensile strength of screw (DIN)	Recommended length				
		M 3	M 4	M 5	M 6/M 8/M 10	M 12
≥ 70	4.8	2A	1,5A	2A	2 A	—
≥ 140	4.8	2A	1,5A	2A	1,5A	1 A
	6.8	2A	1,5A	2A	1,5A	1,5A
	8.8	2A	1,5A	2A	2 A	2 A
≥ 210	6.8	2A	1,5A	2A	1,5A	1 A
	8.8	2A	1,5A	2A	1,5A	1,5A
	12.9	2A	1,5A	2A	1,5A	2 A
	14.9	2A	2 A	2A	2 A	2,5A
≥ 280	6.8	2A	1,5A	2A	1,5A	1 A
	8.8/12.9	2A	1,5A	2A	1,5A	1,5A
	14.9	2A	1,5A	2A	1,5A	2 A

Example

Shearing strength of the workpiece appr. 160 N/mm², screw M6, strength class 8.8
Recommended length: 2A = 2x6 mm = 12 mm.

Thread repair with Ensats® and Gripp®



Ensats®

is ideally suited for the fast repair of torn and damaged threads. The same screw size can be used again. This gives threads a markedly higher load capacity.

Gripp® is used for the repair of torn spark plug retaining threads in light alloy cylinder heads.

Gripp is installed in the same way as Ensats, but screwed in deeper until the upper rim comes to rest around 1.8 mm under the surface of the cylinder head. The sealing ring of the spark plug is then able to work effectively.

Mini-packs for minor repair requirements are available from tool retailers or from the manufacturer.

The basic Ensats® kit

The basic kit contains 315 self-tapping threaded inserts Ensats-S 302 made of case-hardened, zinc-plated, yellow chromated steel with internal thread from M2.5 to M16.

The Ensats® installation kit.

The installation kit contains 270 self-tapping threaded inserts Ensats-S 302 made of case-hardened, zinc-plated, yellow chromated steel with internal thread from M4 to M8 and the tools required for manual installation (for a more detailed description see page 22).

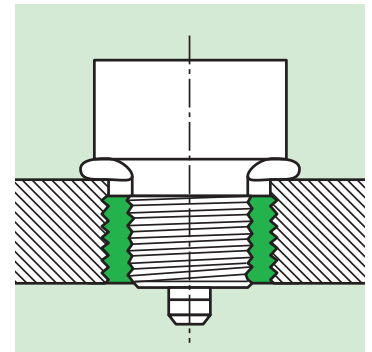

The Gripp® kit

The Gripp kit was put together specifically for the repair of torn and damaged spark plug retaining threads and comes complete with tools for manual installation in two thread sizes:

- Standard: M14 long and short
- Universal: additionally M18



Application

The Ensat-Gripp threaded insert with cutting bores is a self-tapping fastener for the repair of torn and damaged spark plug retaining threads in cylinder

heads.

The Ensat-Gripp is designed to enhance the pull-out strength of the thread.

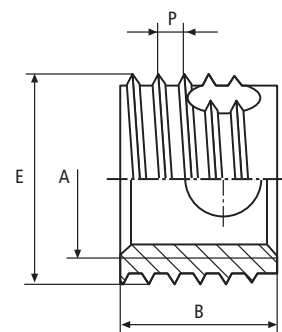

Dimensions in mm

Article no.	Internal thread			External special thread		Length B	Hole size-diameter 1) L
	A	P	DIN	E	P		
304 000 140.160	14	1,25	72502	17,7	1,25	9	17,0
304 000 141.160	14	1,25	72502	17,7	1,25	15	17,0
304 000 180.160	18	1,5	72501	21,7	1,25	9	21,0

1) Guideline values for normal applications. Deviations, depending on the strength of the cylinder head alloy, ± 0.1 mm

Example for finding the article number

Spark plug insert with internal thread A = M14 x 1,25 mm, length B = 9 mm made of case-hardened steel, zinc-plated, yellow chromated: Ensat-Gripp 304 000 140.160

Material

Hardened, zinc-plated, yellow chromated steel

Dimensions in mm

Article no.	Suitable for Gripp	Tool SW D	Length
			B
619 000 140	304 000 140.160	22	97
	304 000 141.160		
619 000 180	304 000 180.160	22	97

Installation tool 619 for manual installation

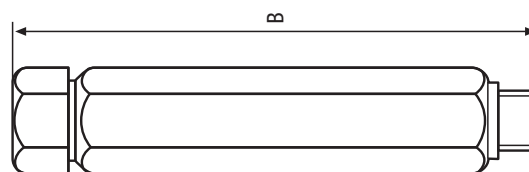

Dimensions in mm

Article no.	Suitable for Gripp	Maximal diameter E	Length
			B ₁
629 000 146	304 000 140.160	50	72
	304 000 141.160		
629 000 187	304 000 180.160	50	73

Installation tool 629 for machine installation

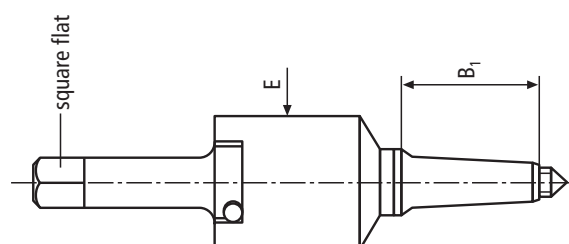

The correct length of the stud for the Ensats with cutting slot / cutting bore results from the pitch of the outside thread (see also illustration below; P=pitch of the outside thread).

Ensats® – driving tools ...

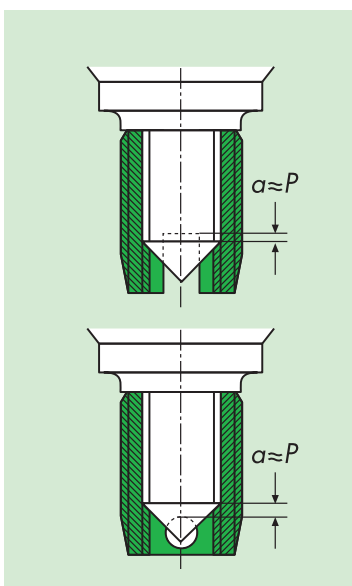

Tool 620 for flush installation

- Square flat
- 1 Shaft
- 4 Pin
- 9 Ball
- 5 Locking screw, colour marking
- 6 Ball bearing
- 2 Shell
- 3 Guide bush
- 7 Stud

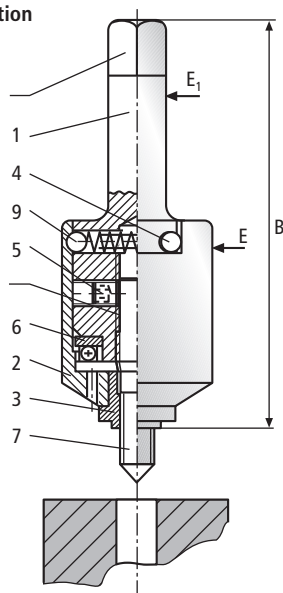

Tool 621 For deep retaining holes

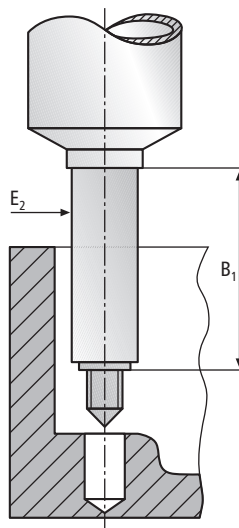

Tool 610 for manual installation

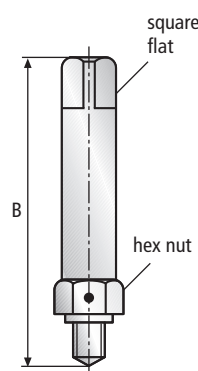

Tool 6102 for Ensats-SBI

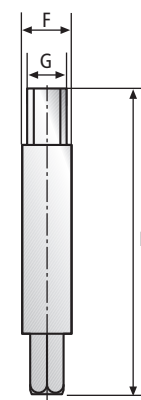

Set or exchange the stud

- Pull off the shell (2) downwards off the shaft (1).
- Release the locking screw (5).
- Screw the stud (7) in or out. The yellow colour marking indicates the flattened surfaces for the locking screws.
- When assembling, tighten both screws (5) evenly.
- Insert the ball bearing (6).
- Push on the shell (2) until the ball stop locks into place. To ensure that the tool functions perfectly, it must be possible to easily rotate the shell. For short Ensats, grind down tool 610 accordingly.
- If you wish the Ensats to be driven

deeper than 0.2 mm below the workpiece surface, screw off the guide bush (3) at the front. Diameter: 0.1 to 0.2 mm smaller than the Ensats retaining hole.

For mounting the thin-walled Ensats (Page 14), modified guide bushes (available on request) should be used.

Dimensions [mm]

For Ensats®	Tool 620								Tool 621				Manual assembly tool 610				For Ensats®-SBI	Tool 6102 Machine/Hand			
	Article-no.								Article-no.				Article-no.					Article-no.			
		Whitworth	UNC	UNF	E	E1	Square SW D	Length B	B1	E2	Length B	Square SW D	Collar SW D		Length B	Square SW G	Shank Ø F				
M 2,5	-	620 000 025	-	-	18	8	6,3	78	621 000 025	40	7	610 000 025	55	5	7	M 2,5	-	-	-		
M 3	Nr. 4	620 000 030	-	620 000 604	18	8	6,3	78	621 000 030	40	7	610 000 030	55	5	7	M 3	-	-	-		
M 3,5	Nr. 6	620 000 035	-	620 000 606	18	8	6,3	78	621 000 035	40	7	610 000 035	60	5	7	M 3,5	-	-	-		
M 4	Nr. 8	620 000 040	-	620 000 608	18	8	6,3	78	621 000 040	40	7	610 000 040	60	5	7	M 4	610 200 040	80	4,9	6	
M 5	Nr. 10	620 000 050	-	620 000 610	24	12,5	10	95	621 000 050	50	9	610 000 050	75	8	13	M 5	610 200 050	90	6,2	8	
M 6	1/4"	620 000 060	620 000 525	620 000 625	24	12,5	10	95	621 000 060	50	10	610 000 060	75	8	13	M 6	610 200 060	100	8	10	
M 8	5/16"	620 000 080	620 000 531	620 000 631	24	12,5	10	95	621 000 080	50	12	610 000 080	75	8	13	M 8	610 200 080	100	8	10	
M 10	3/8"	620 000 100	620 000 537	620 000 637	32	16	12,5	118	621 000 100	60	15	610 000 100	95	12,5	19	M 10	610 200 100	110	9	12	
M 12	7/16"	620 000 120	620 000 544	620 000 644	32	16	12,5	118	621 000 120	60	18	610 000 120	95	12,5	19	M 12	-	-	-	-	
M 14	1/2"	620 000 140	620 000 550	620 000 650	50	25	20	145	621 000 140	60	20	610 000 140	95	12,5	19	M 14	-	-	-	-	
M 16	5/8"	620 000 160	620 000 562	620 000 662	50	25	20	145	621 000 160	60	22	-	-	-	M 16	-	-	-	-		
M 18	-	620 000 180	-	-	50	25	20	145	621 000 180	60	24	-	-	-	M 18	-	-	-	-		
M 20	-	620 000 200	-	-	58	25	20	169	621 000 200	60	26	-	-	-	M 20	-	-	-	-		
M 22	-	620 000 220	-	-	58	25	20	169	621 000 220	60	28	-	-	-	M 22	-	-	-	-		
M 24	-	620 000 240	-	-	70	30	25	198	621 000 240	60	32	-	-	-	M 24	-	-	-	-		
M 27	-	620 000 270	-	-	70	30	25	198	621 000 270	60	35	-	-	-	M 27	-	-	-	-		
M 30	-	620 000 300	-	-	70	30	25	198	621 000 300	60	38	-	-	-	M 30	-	-	-	-		

Tools 620 and 621 also fit within the coloured lines for other thread dimensions, if the guide bush and stud are exchanged.

Manual Ensat® Installation ...



Manual installation with driving tool and tap wrench:

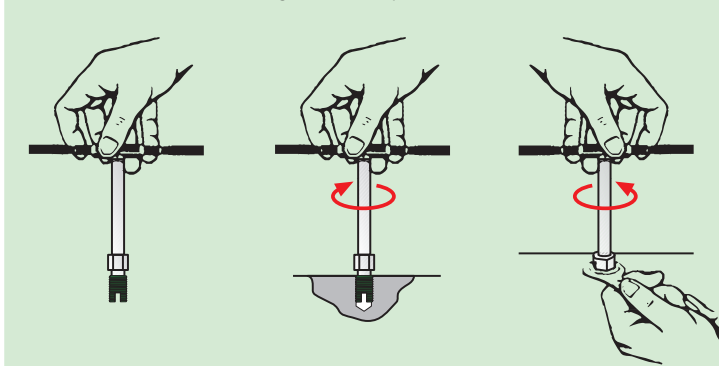

Emergency installation using screw and nut:

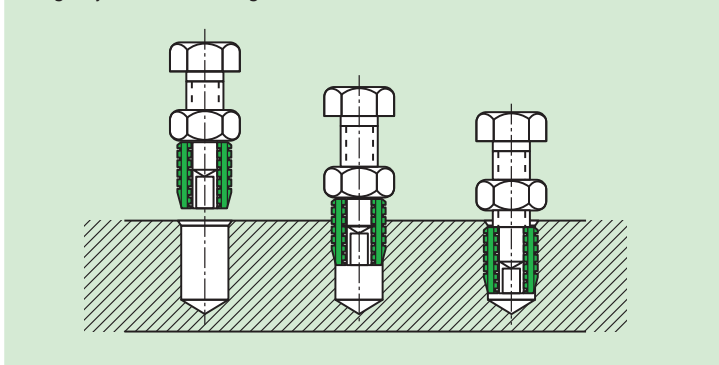

Manual installation

Manual driving takes place using the driving tools 620, 621 or 610 and a tap wrench:

1. Drill the hole: see page 6 for the correct diameter, countersink if necessary.
2. Screw the Ensat onto the driving tool with the cutting slot or cutting bore pointing downwards.
3. Drive in the Ensat until appr. 0.1 - 0.2 mm below the surface of the workpiece. Ensure that it does not tilt! When using tool 620 and 621, the rotatable shell must rest against the externally visible stop pins in such a way that it is driven round clockwise by the pins.
4. Back out the driver tool. During this process, tool 620 or 621 is automatically released from the Ensat. Tool 610: Hold the hex nut using a spanner until the lock breaks.

Driving into steel

With Ensat® 302:

Pre-cut the thread using the drill (max. centre cutter), set the threaded stud of the tool to the full Ensat length (tool 610 cannot be adjusted).

With Ensat® 307 / 308:

In steel up to medium strength, pre-cutting is not required.

Up to M12, we recommend the use of **Mubux®-M** for steel.

Mubux®-M0 installation

Pre-cut the retaining thread with customary thread tapping tool, then drive in as for the Ensat.





Machine installation ...

Machine driving process

1. Precisely position the workpiece to ensure that the hole and machine spindle are in exact alignment (do not tilt). Set the machine to the precise driving depth (appr. 0.1 – 0.2 mm below the surface of the workpiece).
2. Turn the machine to clockwise rotation. At the start of the driving process, the rotatable external shell of the tool must be resting against the external visible stop pins in such a way that it is driven by the pins in the clockwise direction.
3. Feed the Ensat towards the tool (slot or cutting hole facing downwards) and grip for the duration of 2 to 4 revolutions.
4. Actuate the operating lever of the machine until the Ensat cuts into the borehole. The remainder of the driving process takes place without actuating the feed.
5. Switch on the reversing function. Always avoid setting the tool down hard on the workpiece, as this can lead to breaking both the tool and the Ensat.

Excessively hard contact of the tool can damage the play-free fit of the Ensat and so reduce the pull-out strength. If necessary, the driving speed may have to be adapted in line with the necessary reversal time.

Machine installation takes place with production tool 620 or 621, integrated in a:

1. Thread tapping machine

2. Use a **drill press** fitted with a reversing tapping attachment or a tapping machine which is not pitch controlled.
Important: Never exceed the maximum admissible driving torque.

3. Special manual machine with bit stop and reversing system.

4. For large-scale series:

Single or multiple installation machines with pneumatic or electric drive, semi or fully automatic, CNC.

Recommended speed values for light alloys:

Ensats® Internal thread	Speed [min ⁻¹]
M 2,5 / M 3	650 - 900
M 4 / M 5	400 - 600
M 6 / M 8	280 - 400
M 10 / M 12	200 - 300
M 14 / M 16	150 - 200
M 18 / M 20	120 - 200
M 22 / M 24	100 - 160
M 27 / M 30	80 - 140

Maximum admissible installation torque

Ensats® M 2,5	1,5 Nm
Ensats® M 3	2,5 Nm
Ensats® M 4	5,5 Nm
Ensats® M 5	10 Nm
Ensats® M 6	15 Nm
Ensats® M 8	28 Nm
Ensats® M 10	40 Nm
Ensats® M 12	60 Nm

Lubrication

Only in the case of materials with difficult cutting properties.

For medium-hard light alloys:

Cutting oil, spirit or petroleum.

For tough light alloys and cast iron:

Cutting oil with appr. 5 – 8% molybdenum sulphide.

Torque M

The maximum admissible torque depends on:

1. The axial load capacity of the tool stud
2. The pressure resistance capacity of the Ensats® in the axial direction.

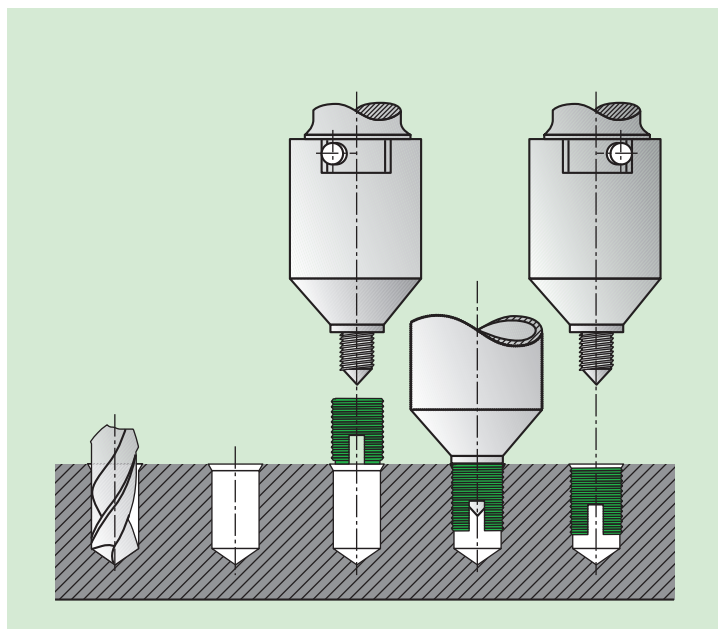

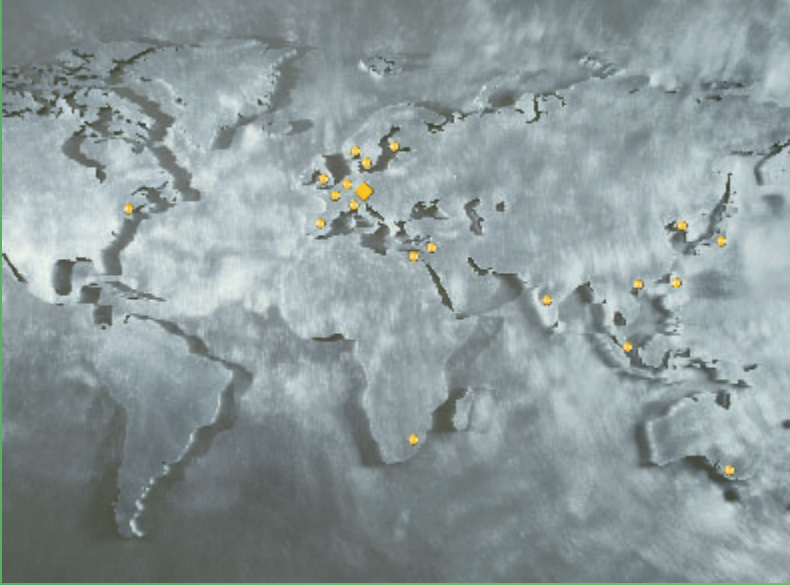

KerbKonus - close to its customers. Around the world. Across every sector of industry.

First and foremost, for you customer proximity means a rapid response to your requirements and the fast, efficient realisation of the right fastening solution for you.

For us, customer proximity is far more than just another watchword - it is an important strategic instrument. Our technical sales consultants are available locally to talk to you around the world, ready to offer sound advice when it comes to the reliable, economical application of modern fastening technology. Advisory activities are coordinated through the headquarters in Amberg.

Why not simply call us to arrange an appointment?

Kerb-Konus-Vertriebs-GmbH

P.O.Box 16 63
D-92206 Amberg

Phone ++49 9621 679-0
Fax ++49 9621 679444
e-mail KKV-Amberg@kerbkonus.de
internet www.kerbkonus.de

... in Germany

Amberg Headquarters
Production and Sales

Kerb-Konus-Vertriebs-GmbH
Werner-von-Braun-Straße 7
D-92224 Amberg

Production plant
Hadamar

... and around the world.

Kerb-Konus Fasteners Pvt. Ltd.
Kolhapur/India

KKV Corp.
Osaka/Japan

KKV AG
Sattel/Switzerland

Precision Fasteners Inc.
Flanders, New Jersey/USA

Kerb-Konus Italia s.r.l.
Mulazzano/Italy

Kerb-Konus UK
Telford/Shropshire
UK

Kerb Konus Espanola S. A.
Alcorcon/Madrid
Spain

KKV Belgium
Gooik/Belgium

Sofrafix
Savigny-le-Temple
France

Other foreign agents in a wide number of countries.
Addresses on request or under www.kerbkonus.de

